

# GSA 130

MOTORLU DÜŞEY  
SÜRME SİSTEMİ



# GSA 130

MOTORLU DÜŞEY SÜRME SİSTEMİ



ACCURACY



HARMONY



BALANCE

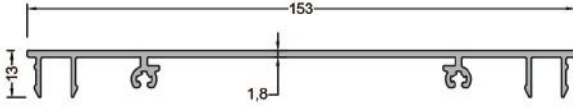

420-4001 ( 1,060 kg/mt )

GSA130 MOTOR KUTU ÖN-ARKA PROFİLİ

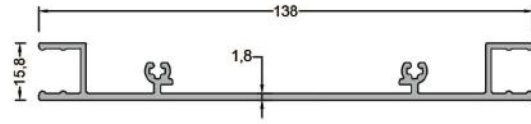

420-4002 ( 1,120 kg/mt )

GSA130 MOTOR KUTU ALT-ÜST PROFİLİ

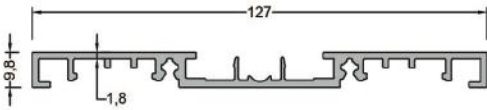

420-1101 ( 1,122 kg/mt )

GSA130 KASA PROFİLİ

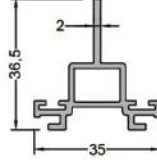

420-2101 ( 0,506 kg/mt )

GSA130 KAYIŞ ADAP. LÜ KANAT PRF.

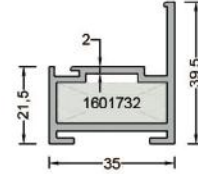

420-2103 ( 0,728 kg/mt )

GSA130 KANAT PROFİLİ

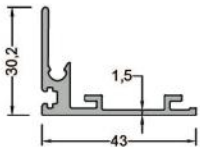

420-6001 ( 0,491 kg/mt )

GSA130 KENET PROFİLİ

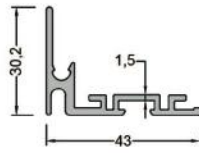

\*420-6008 ( 0,504 kg/mt )

GSA130 KENET PROFİLİ

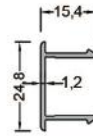

410-6003 ( 0,173 kg/mt )

GSAL100 RAY KAPAK PROFİLİ

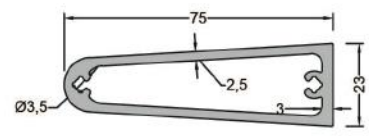

420-6010 ( 1,330 kg/mt )

KENET KAPAK PROFİLİ



420-5001 ( 0,177 kg/mt )

GSA130 KAPAK PROFİLİ

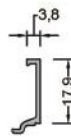

420-5003 ( 0,100 kg/mt )

CAM ÇİTASI

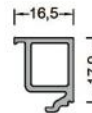

420-5004 ( 0,266 kg/mt )

TEK CAM ÇİTASI

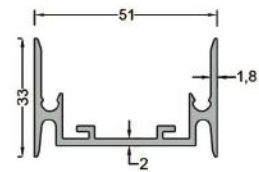

420-6011 ( 0,750 kg/mt )

KAPI KENET PROFİLİ

# GSA 130

MOTORLU DÜŞEY SÜRME SİSTEMİ

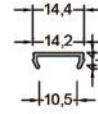
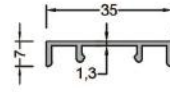
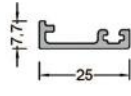
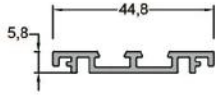
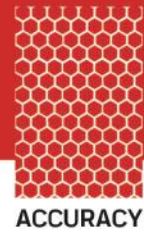

420-6005 (0,325 kg/mt )

MOTOR KUTU BİNİ ADAPTÖR PR.

420-6007 (0,184 kg/mt )

MOTOR KUTU BİNİ PROFİLİ

420-6103 (0,203 kg/mt )

GSA130 KASA KAPAK PROFİLİ

648-7101 (0,051 kg/mt )

D48A06 ADAPTÖR PROFİLİ

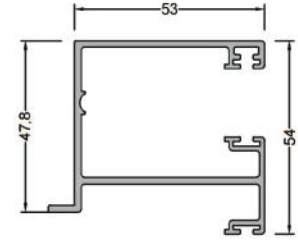
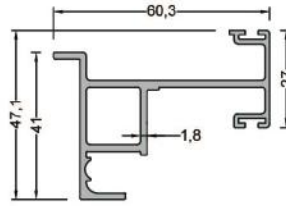
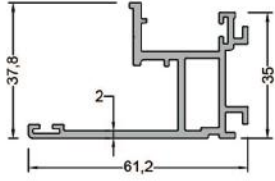

420-6104 (0,930 kg/mt )

GSA130 AÇILIR KANAT PROFİLİ

420-6009 (0,920 kg/mt )

GSA130 RAY KASA ADAPT. PRF.

420-6002 (1,047 kg/mt )

GSA130 RAY PROFİLİ

## GSA 130 Sisteminin Varyasyonları

GSA130-W Pencereleer

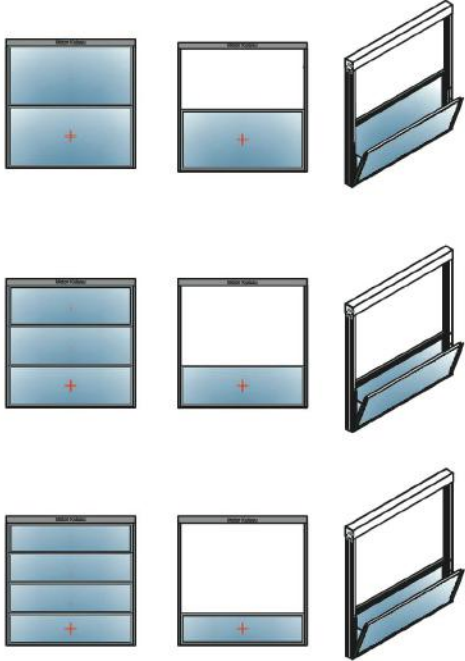

GSA130-D Kapılar

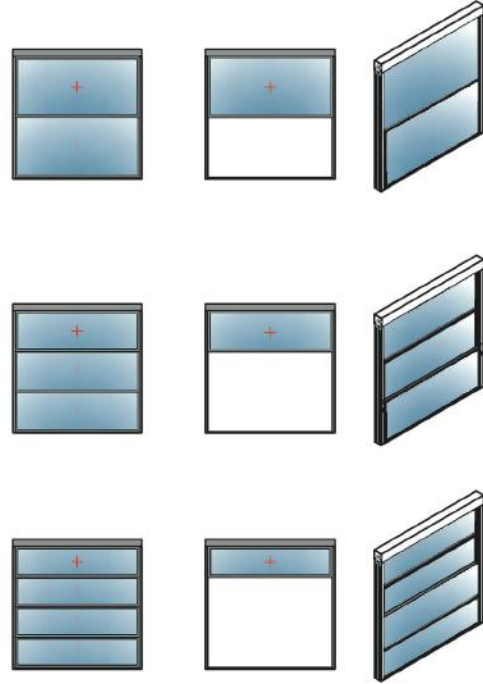

# GSA 130

MOTORLU DÜŞEY SÜRME SİSTEMİ



ACCURACY

HARMONY

BALANCE

ÜRÜN ÇİZİMİ	ÜRÜN KODU	ÜRÜN ADI
	9516126	SOMFY MOTOR MOTOR KUTUSU YAN SOL
	9516328	MOTOR KAPAK SAĞ (SOMFY/BECKER)
	9516329	MOTOR KAPAK SOL - (SOMFY)
	9516336	MOTOR KAPAK SOL - (SOMFY)
	9516123	MOTOR KUTUSU YAN SAGI SOL
	9516124	MOTOR KUTUSU YAN SAGI SAĞ
	9516336	MOTOR KUTUSU YAN İÇ SAGI SOL
	9516332	MOTOR KUTUSU İÇ GÖVDE SAĞ (SOMFY/BECKER)
	9516333	MOTOR KUTUSU İÇ GÖVDE SOL (SOMFY)
	6516205	MOTOR KUTUSU DESTEK SAGI
	9512103	70'LİK BORU BAŞI
	9516300	GSA130 KANAT BAĞLANTI
	9516701	ZİNCİR (06B-1)
	9516400	ZİNCİR KİLİDİ (06B-1)
	9516115	ZİNCİR DİŞLİ 70'LİK BORU İÇİN
	9512106	70'LİK GALVANİZ BORU
	3516206	KASA KÖŞE BAĞLANTI
	1601732	KÖŞE BAĞLANTI 32x11,8x32 24-101
	1601758	KÖŞE BAĞLANTI 30,5x11,5x29 24-110
	0901905	KELEBEK MENTEŞE ALÜMİNYUM
	9503302	PVC KANAT KAPAK SETİ
	9503301	PVC AÇILIR KANAT KAPAK SETİ

ÜRÜN ÇİZİMİ	ÜRÜN KODU	ÜRÜN ADI
	3516207	TOPUZLU EMNİYET PİMİ
	0521210	ANAHTARLI PANO KİLİT MEKANİZMASI
	4016008 18-109A	CEPHE ÇELİK MAKAS KADEMELİ 200mm
	9501004	BECKER MOTOR 120 N/m
	9427001	SOMFY MOTOR 120 N/m
	9501104	BECKER KUMANDA 1 KANAL
	9501101	BECKER KUMANDA 5 KANAL
	9501106	BECKER KUMANDA 10 KANAL
	9501211	SOMFY KUMANDA 4 KANAL
	9501210	SOMFY KUMANDA 5 KANAL
	9501212	SOMFY KUMANDA 16 KANAL
	5303218	CAM TAKOZU 80*20*2 mm
	5303207	CAM TAKOZU 80*25*5 mm
	7599222	CAMLAMA BANTI 15*2 mm
	7605502	SOULDAL FIX HIGHTACK 290 ml
	1501101	YHB VİDA M3.9*16
	1501125	YSB VİDA M3.9*16
	1606951	SOMFY MOTOR ZAMAK
	9504102	SOMFY MOTOR WHEEL
	9504101	SOMFY MOTOR CROWN
	1601400	GSA130 TAKVİYE KAPAK
	3203003	FİTİL KİL ASETATLI 4.8*1000 MM

ÜRÜN ÇİZİMİ	ÜRÜN KODU	ÜRÜN ADI
	3203004	KİL FİTİL 6,7*1000mm
	3203012	FİTİL KİL 6.7*1200 MM
	3203017	KİL FİTİL 4,8*1000mm
	3203020	KİL FİTİL 4,8*500 mm
	3202113	İÇ CAM FİTİLLİ 2-3 mm
	3202116	İÇ CAM FİTİLLİ 8-9 mm
	3202314	DERZ FİTİLLİ
	6502601	SİNEKLİK FİTİLİ 5,0 mm



# GSA 130

MOTORLU DÜŞEY SÜRME SİSTEMİ



ACCURACY



HARMONY



BALANCE

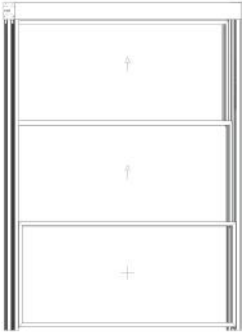

Dikey Kesit  
Iso Cam 24mm  
Cam Kapalı

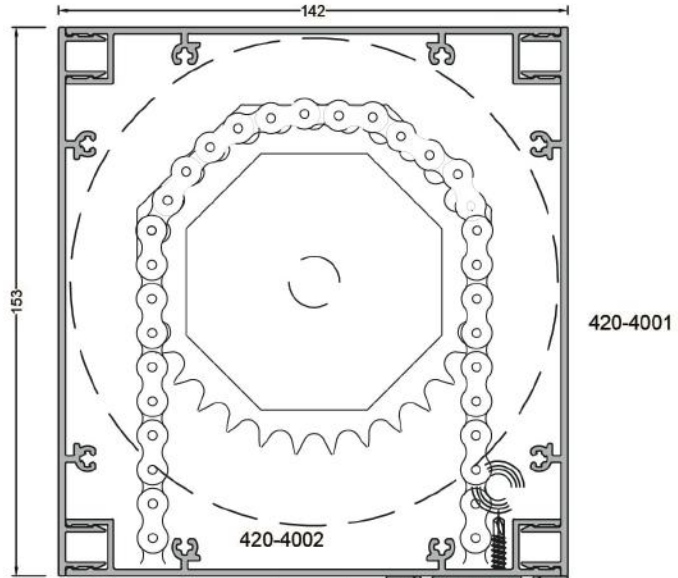

420-4001

420-4002

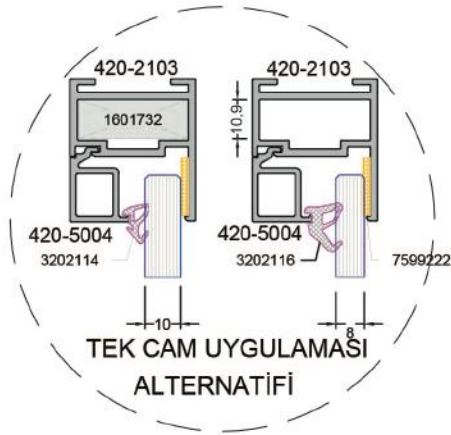

TEK CAM UYGULAMASI  
ALTERNATİFİ

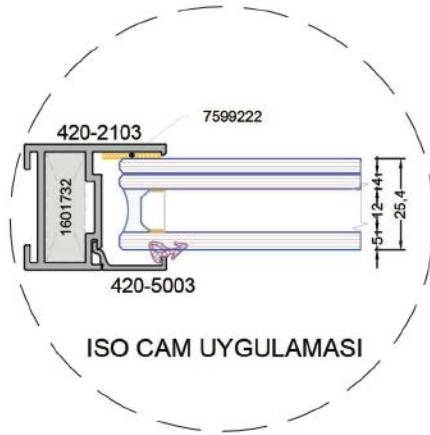

ISO CAM UYGULAMASI

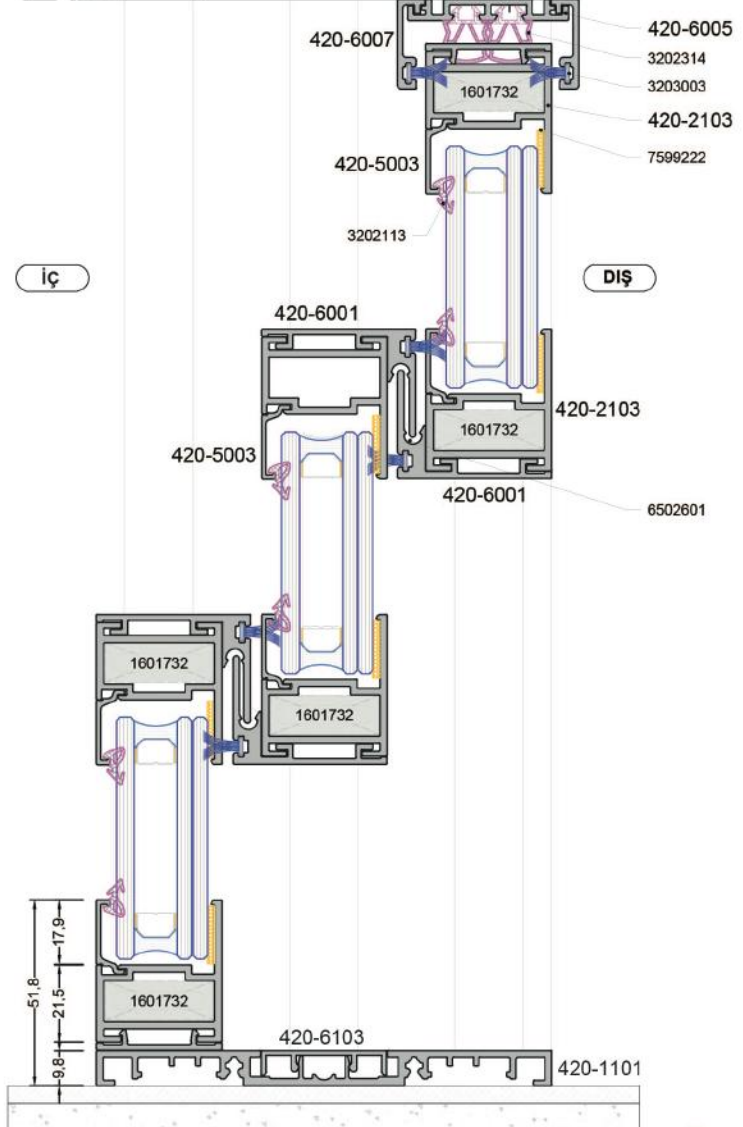

iç

DIŞ

Ölçü 1:2

# GSA 130

MOTORLU DÜŞEY SÜRME SİSTEMİ

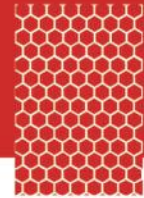

ACCURACY



HARMONY



BALANCE



Dikey Kesit  
ISO Cam 24 mm  
Pencere Açık

420-4001

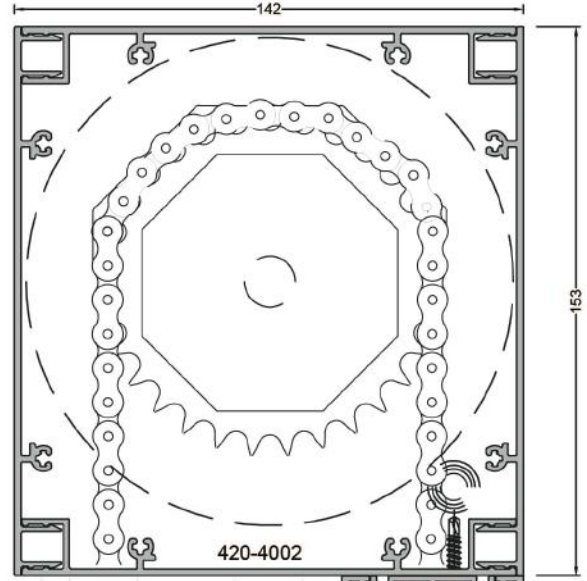

Yatay Kesit

ISO cam 4+4 Lamine Cam+12 Boşluk+ 6mm Temperli Cam

DIŞ

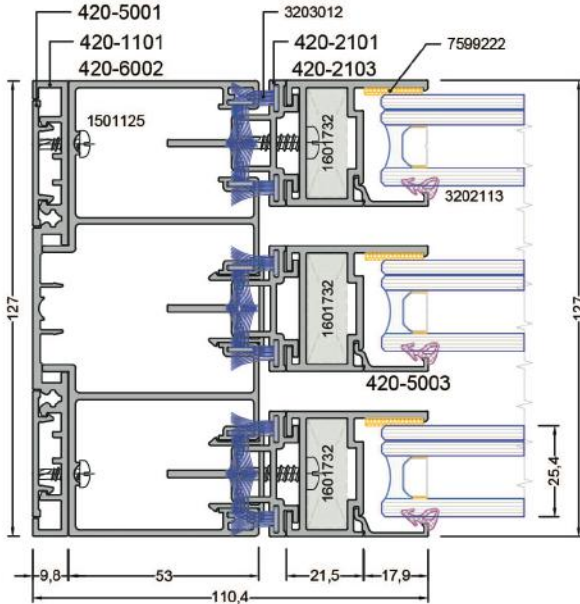

İÇ

İÇ

DIŞ

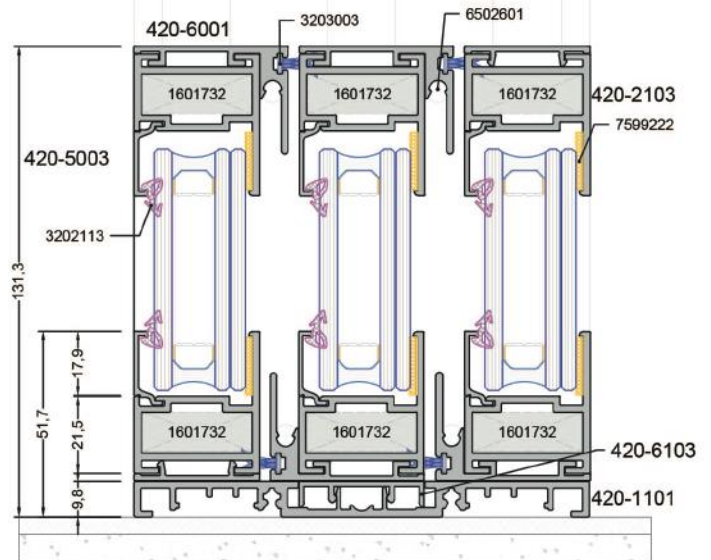

Ölçü 1:2

# GSA 130

MOTORLU DÜŞEY SÜRME SİSTEMİ

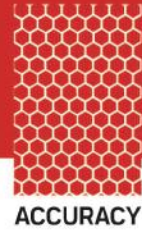

ACCURACY

HARMONY

BALANCE

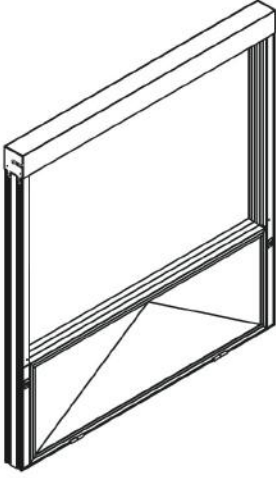

Yatay Kesit  
Açılır Pencere Güvenlik Pimi (Temizlik için)

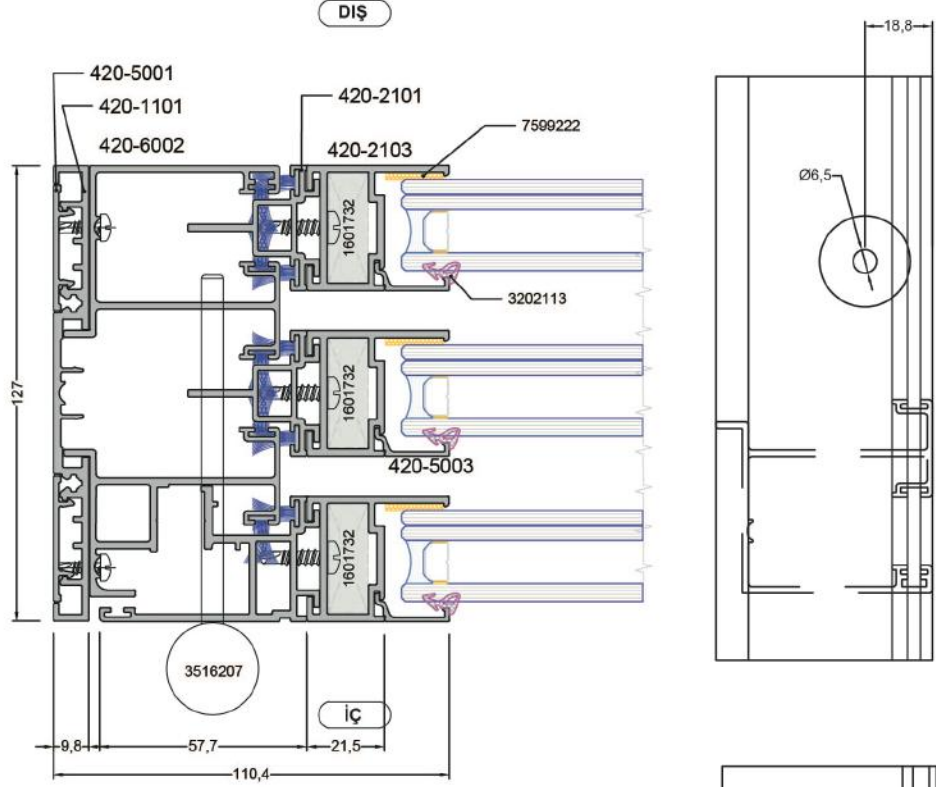

Yatay Kesit  
Açılır Pencere Kilit Mekanizması

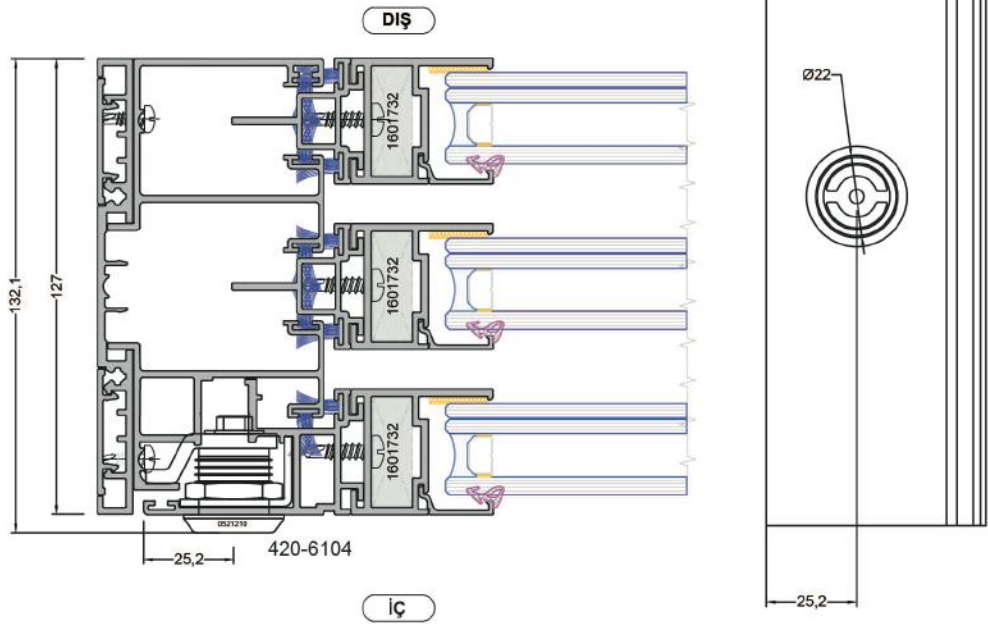

Ölçü 1:2

# GSA 130

MOTORLU DÜŞEY SÜRME SİSTEMİ

ACCURACY

HARMONY

BALANCE

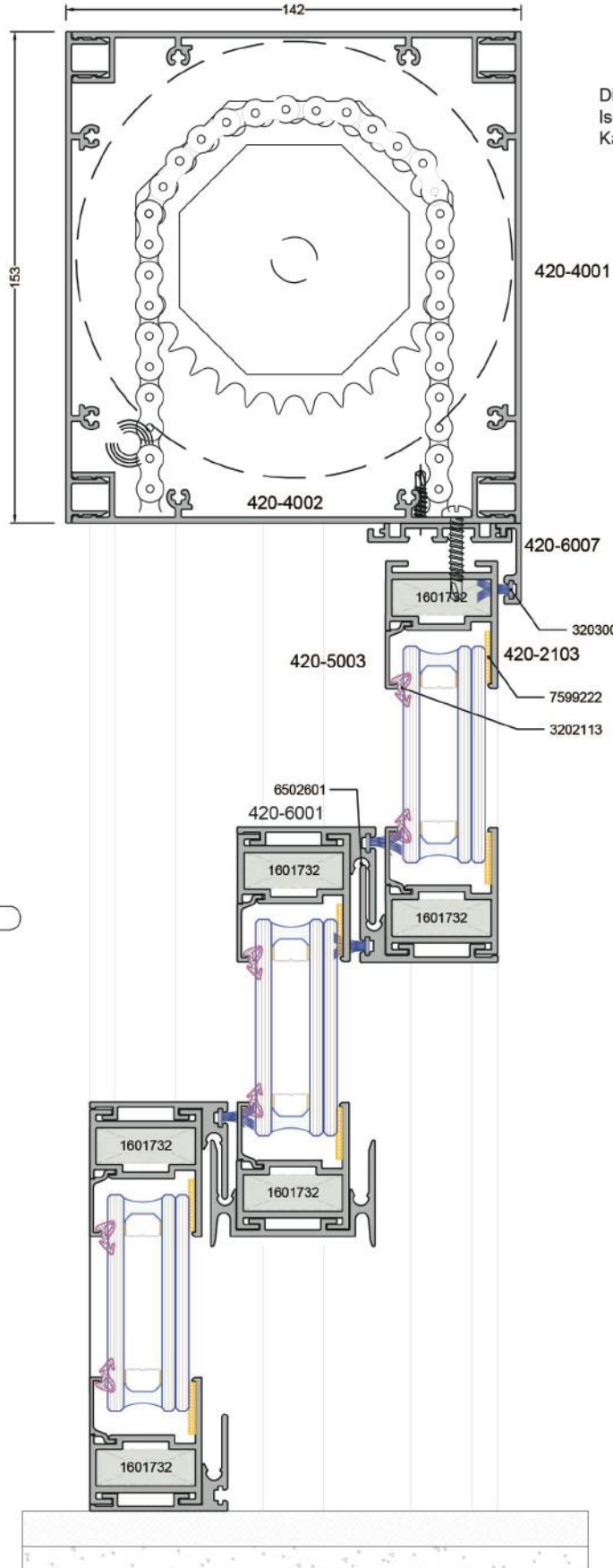
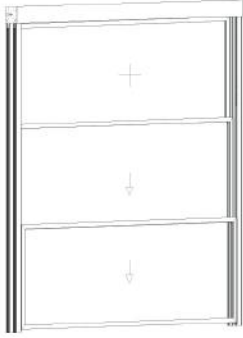

Dikey Kesit  
Iso Cam 24mm  
Kapı Sistemi Kapalı

iç

dış

Ölçü 1:2



# GSA 130

MOTORLU DÜŞEY SÜRME SİSTEMİ

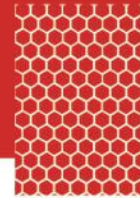

ACCURACY



HARMONY



BALANCE

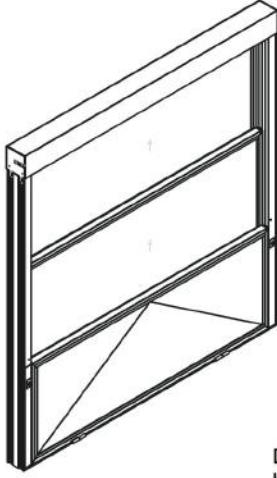

Dikey Kesit  
Iso Cam 24mm  
Pencere Açık

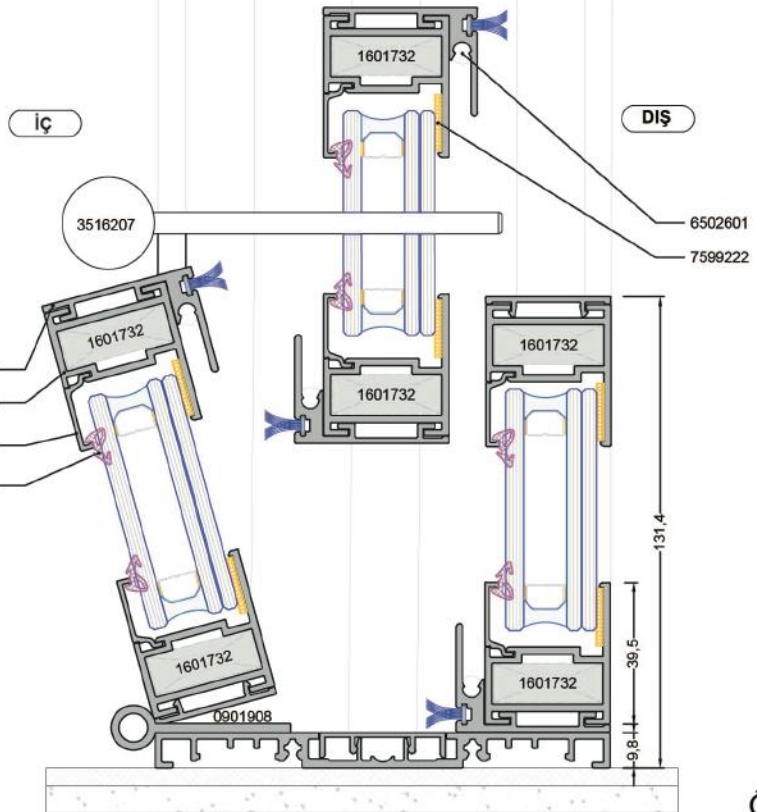
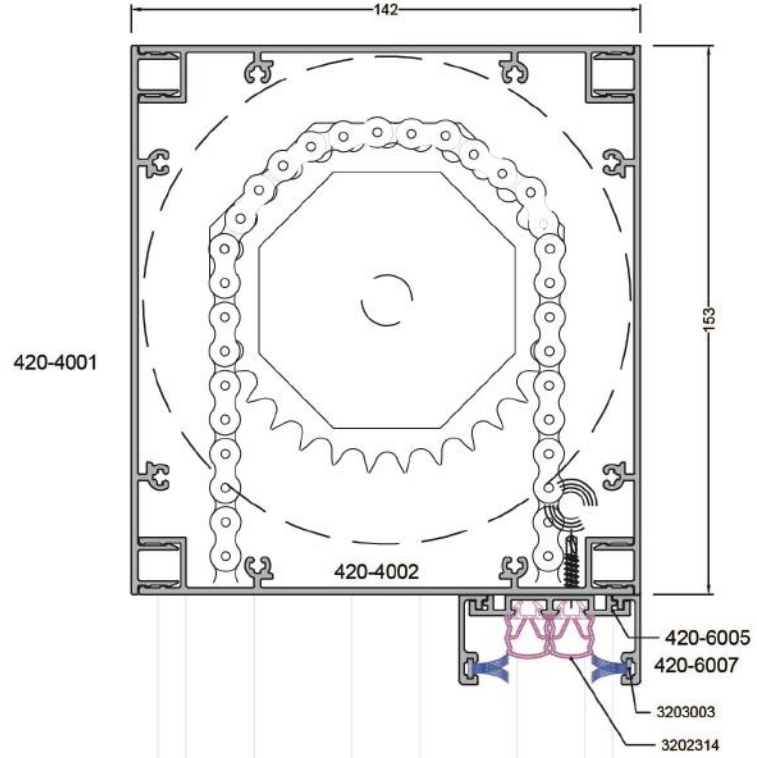

Ölçü 1:2

# GSA 130

MOTORLU DÜŞEY SÜRME SİSTEMİ

ACCURACY

HARMONY

BALANCE

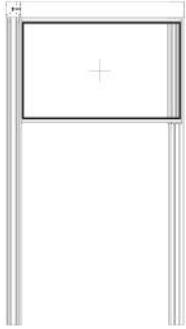

Kanat Destek Profilleri ile Güçlendirilmiş (3500mm den geniş)

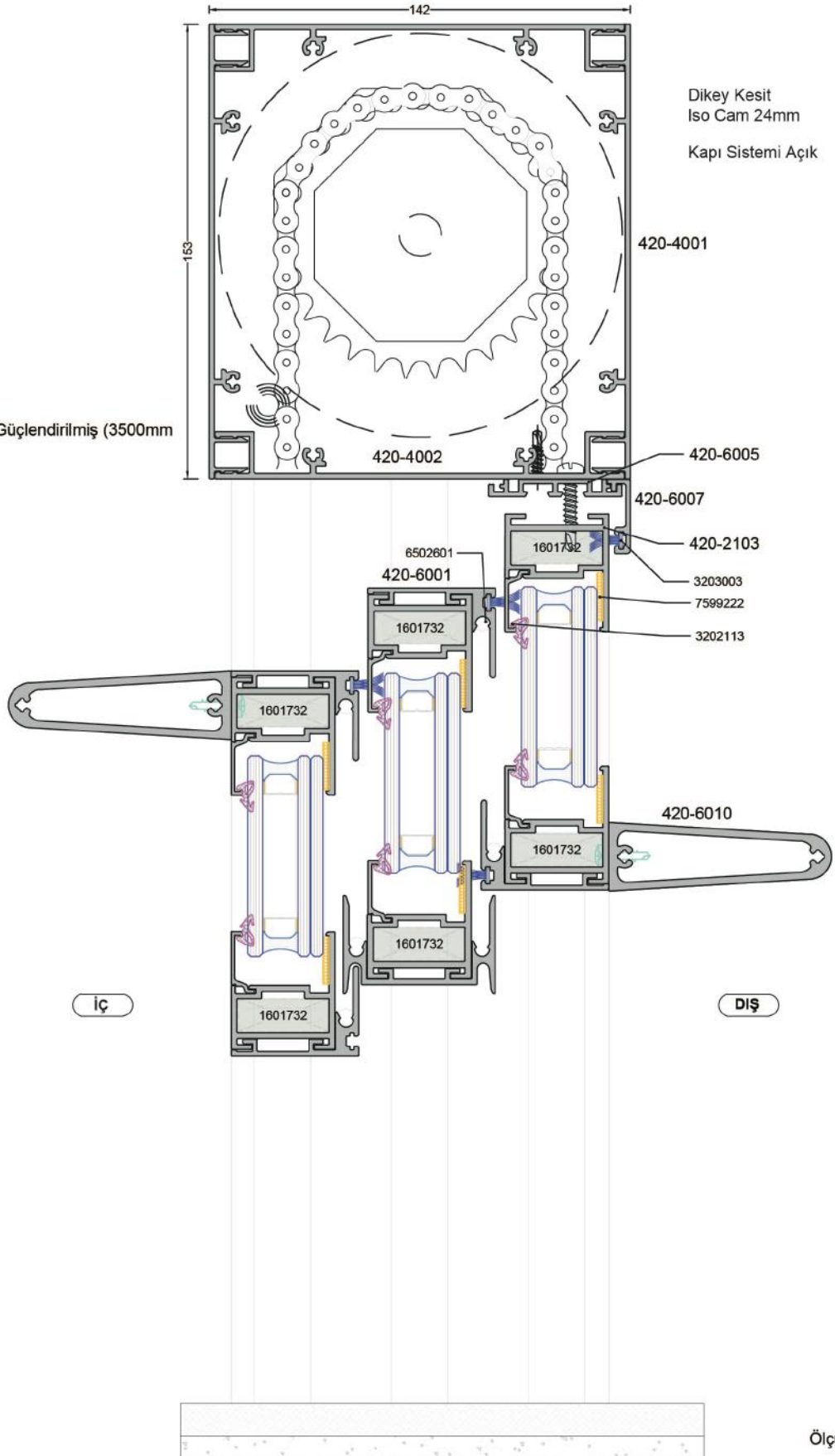

# NOTLAR

A series of horizontal dotted lines for writing notes.