

IPA 45

OFİS BÖLME SİSTEMİ

IPA 45

OFİS BÖLME SİSTEMİ

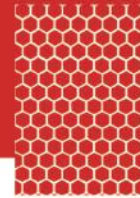

ACCURACY



HARMONY



BALANCE

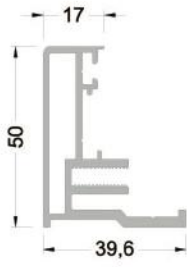

645-1101 (1,030 kg/mt)
IPA45F01 KASA PROFİLİ

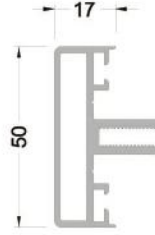

645-2101 (0,823 kg/mt)
IPA45M01 ORTA KAYIT PROFİLİ

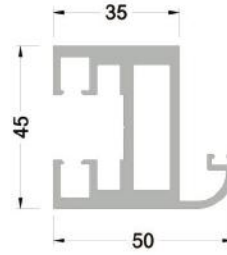

645-5101 (1,728 kg/mt)
IPA45F05 KASA PROFİLİ

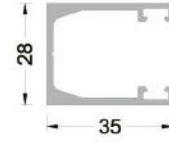

645-1201 (0,542 kg/mt)
IPA45F03 KASA PROFİLİ

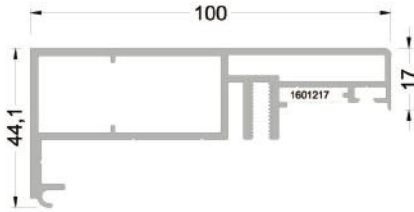

645-4101 (1,727 kg/mt)
IPA45F02 KASA PROFİLİ

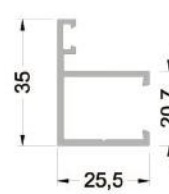

645-1202 (0,394 kg/mt)
IPA45F04 KASA PROFİLİ

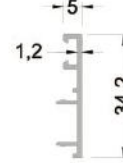

645-7201 (0,174 kg/mt)
IPA45P04 KAPAK PROFİLİ

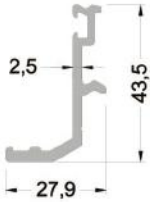

645-6201 (0,527 kg/mt)
IPA45P02 BASKI PROFİLİ

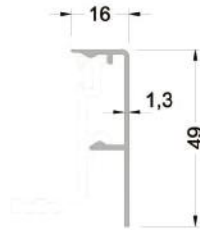

645-7101 (0,270 kg/mt)
IPA45P01 KAPAK PROFİLİ



550-6101 (0,425 kg/mt)
W50P01 BASKI KAPAK PROFİLİ

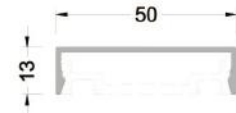

550-6201 (0,277 kg/mt)
W50P03 KAPAK PROFİLİ

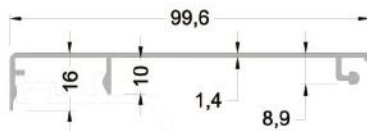

645-7102 (0,529 kg/mt)
IPA45P03 KAPAK PROFİLİ

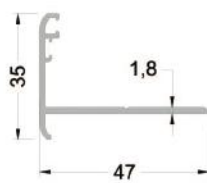

645-8101 (0,386 kg/mt)
IPA45A01 KANAT ADAPTÖR PR.

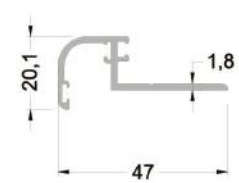

645-8102 (0,374 kg/mt)
IPA45A02 CAM KAPI ADAPTÖRÜ

IPA 45

OFİS BÖLME SİSTEMİ

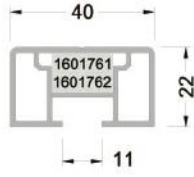

648-3108 (0,647 kg/mt)
D48V08 KANAT PROFİLİ

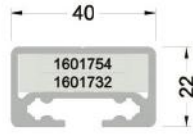

648-3102 (0,805 kg/mt)
D48V02 KANAT PROFİLİ

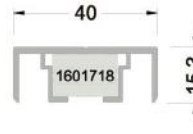

648-3106 (0,424 kg/mt)
D48V06 LAMİNANT KAPI PROFİLİ



648-3104 (0,230 kg/mt)
D48V04 LAMİNANT KAPI PROFİLİ

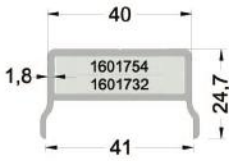

648-3103 (0,572 kg/mt)
D48V03 LAMİNANT KANAT

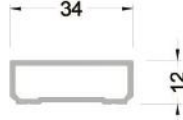

648-2103 (0,300 kg/mt)
D48M03 KAYIT PROFİLİ

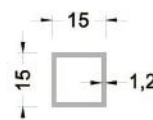

645-8201 (0,179 kg/mt)
AB12-150.150



645-8301 (0,121 kg/mt)
CAM H PROFİLİ



645-8302 (0,116 kg/mt)
CAM H PROFİLİ

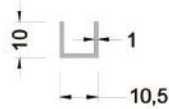

645-8303 (0,083 kg/mt)
CAM H PROFİLİ

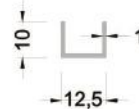

645-8302 (0,116 kg/mt)
CAM H PROFİLİ

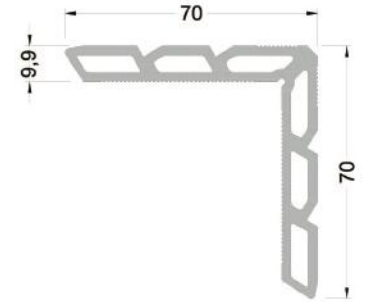

1099 (2,047 kg/mt)
L099 KÖŞE TAKOZU

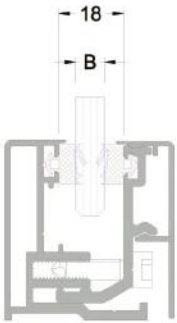

CAM KALINLIĞINA GÖRE CAM ÇİTASI SEÇİM TABLOSU

OPTION TABLE ACCORDING TO GLAZING BEAD THICKNESS

CAM KANLİNLİĞİ GLASS THICKNESS (B)	A	C
8 mm	3202126	3202126
10 mm	3202126	3202125
12 mm	3202125	3202125



CAM KALINLIĞINA GÖRE CAM ÇİTASI SEÇİM TABLOSU

OPTION TABLE ACCORDING TO GLAZING BEAD THICKNESS

CAM KANLİNLİĞİ GLASS THICKNESS (B)	A	C
8 mm	3202115	3202115
10 mm	3202113	3202115
12 mm	3202113	3202113

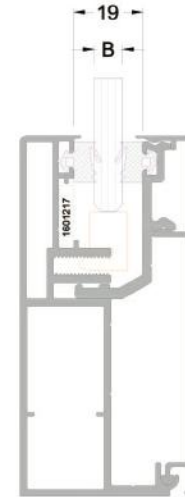

CAM KALINLIĞINA GÖRE CAM ÇİTASI SEÇİM TABLOSU

OPTION TABLE ACCORDING TO GLAZING BEAD THICKNESS

CAM KANLİNLİĞİ GLASS THICKNESS (B)	A	C
8 mm	3202126	3202126
10 mm	3202125	3202125

IPA 45

OFİS BÖLME SİSTEMİ

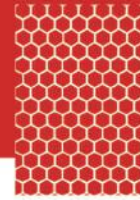

ACCURACY



HARMONY



BALANCE

ÜRÜN ÇİZİMİ	ÜRÜN KODU	ÜRÜN ADI
	3202125	FİTİL İÇ CAM 3 MM 05F-030
	3202126	FİTİL İÇ CAM 4,5 MM 05F-045
	3202113	FİTİL DOĞRAMA İÇ CAM 2-3 MM
	3202114	FİTİL DOĞRAMA İÇ CAM 4-5 MM
	3202115	FİTİL DOĞRAMA İÇ CAM 6-7 MM
	3202307	FİTİL DOĞRAMA KANAT 03F-09
	3202303	FİTİL DOĞRAMA KANAT 03F-08
	1601754	KÖŞE BAĞLANTI MONTİÇELİ 32X10,7 23-105
	1601762	KÖŞE BAĞLANTI MONTİÇELİ 16,7X10,5 23-106
	1601718	KÖŞE BAĞLANTI 18x11,8x18 24-102
	1601732	KÖŞE BAĞLANTI 32x11,8x32 24-101
	1601761	KÖŞE BAĞLANTI 16,7x11x14,5 24-113
	1601206	KÖŞE ÇAVUŞU CL-10
	1601217	KÖŞE ÇAVUŞU FUJI 17x4.3

ÜRÜN ÇİZİMİ	ÜRÜN KODU	ÜRÜN ADI
	1601501	IPA45-J01 ORTA BAĞLANTI PR.
	1601502	IPA45-J02 ORTA BAĞLANTI PR.
	1601503	IPA45-J03 ORTA BAĞLANTI PR.
	5303200	AYARLI CAM TAKOZU IPA45-01
	5303205	SABİT CAM TAKOZU IPA45-02
	0901905	KELEBEK MENTEŞE 10-118A
	0907905	KELEBEK MENTEŞE 10-118B
	0901908	YAPRAK KAPI MENTEŞE 10-109
	0101927	KAPI KOLU HOPPE GÖVDE ATLANTA
	5501946	KAPI KOLU HOPPE AYNA
	5501943	KAPI KOLU HOPPE ANAHTAR
	0101929	KAPI KOLU HOPPE MANDAL
	5501944	KAPI KOLU HOPPE DİL SETİ 60MM
	5501945	KAPI KOLU HOPPE DİL SETİ 70MM

ÜRÜN ÇİZİMİ	ÜRÜN KODU	ÜRÜN ADI
	0101918	KAPI KOLU HOPPE KARŞILIK
	5501304	JUNIOR OFFICE YAPRAK MENTEŞE
	11.0349G	JUNIOR OFFICE GÖVDE
	11.0348G	JUNIOR OFFICE CAM CAMA KARŞILIK
	5501323	JUNIOR OFFICE KİLİT KARŞILIK
	11.0350G	JUNIOR OFFICE KOL
	5501406	CAM KAPI ALT/ÜST KİLİT US10
	7083G	JUNIOR OFFICE BAREL
	5303301	ŞEFFAF I 8 MM
	5303303	ŞEFFAF I 10 MM
	7599226	NORTON ÇİFT TARAF YAPIŞKAN V2800 0.8*15M
	1501207	SAC VİDASI YSB 6,3*25

KASA İÇİN 45° BAĞLANTI

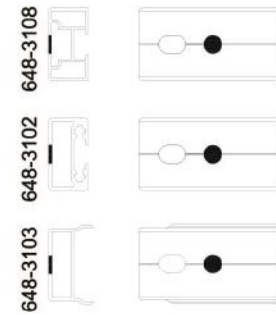
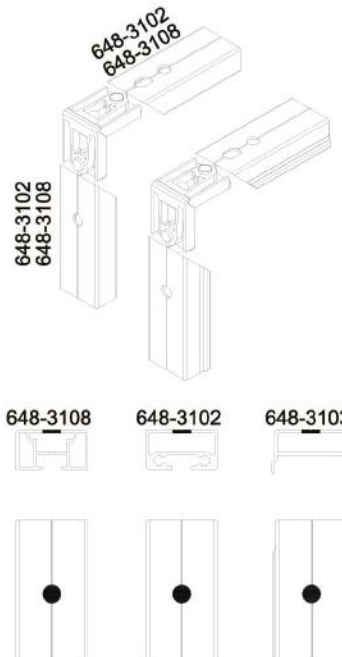
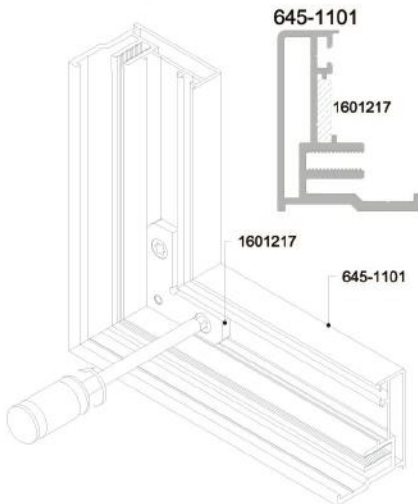

KANATLAR İÇİN 45° BAĞLANTI

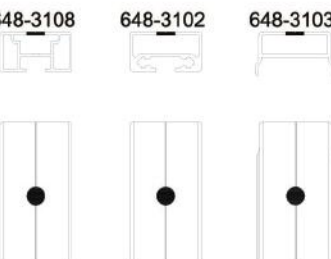

IPA 45

OFİS BÖLME SİSTEMİ



ACCURACY



HARMONY



BALANCE

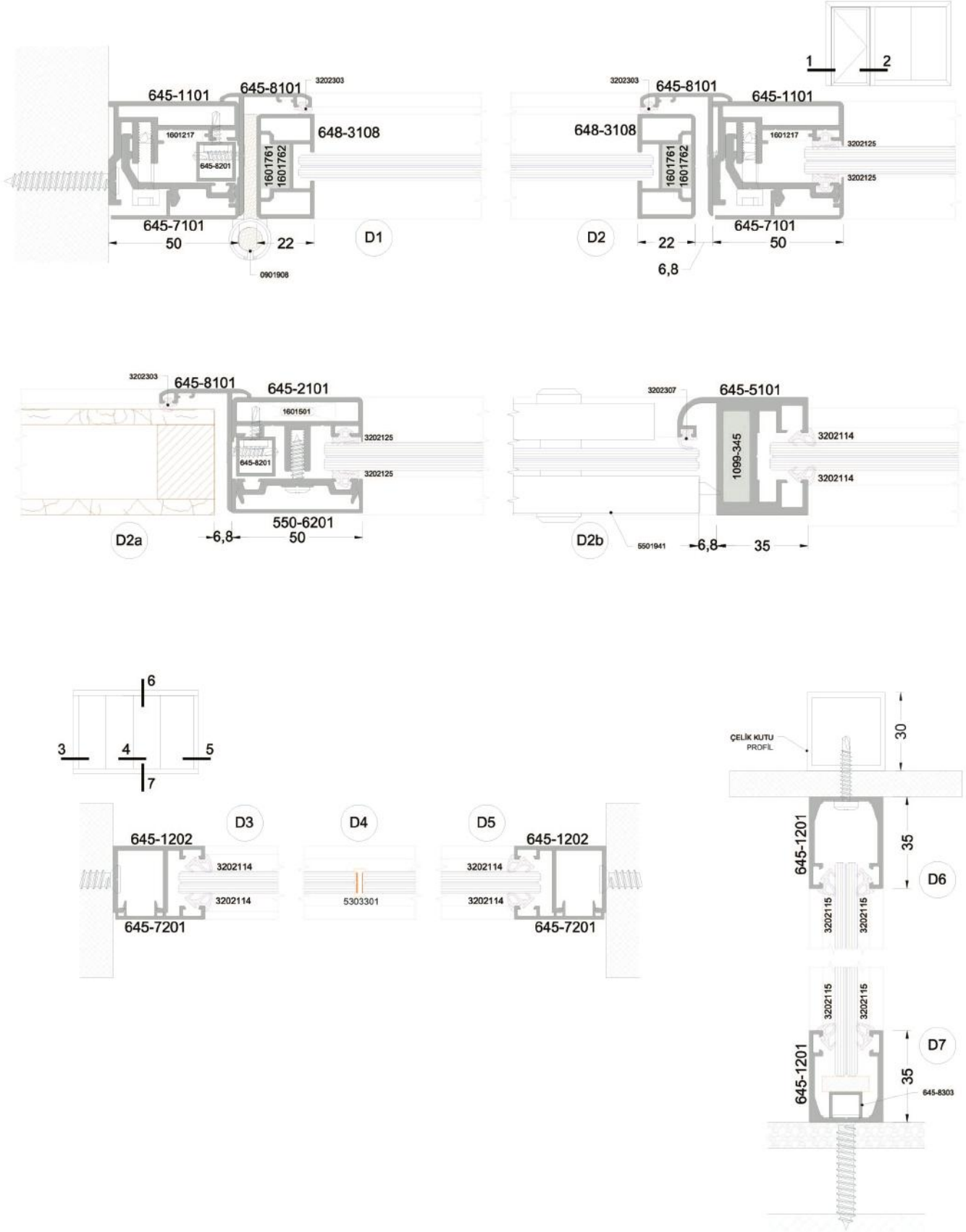

IPA 45

OFİS BÖLME SİSTEMİ

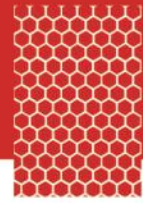

ACCURACY



HARMONY



BALANCE

