

CWA 50

CEPHE SİSTEMİ

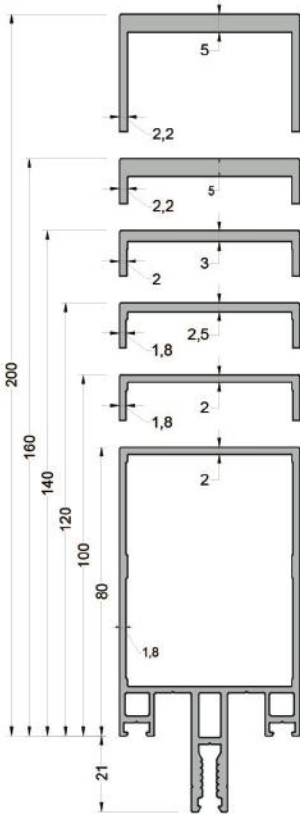
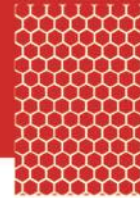

550-1206 (3,738 kg/mt)
W50M07 MÜLYON PROFİLİ

550-1205 (3,261kg/mt)
W50M06 MÜLYON PROFİLİ

550-1204 (2,660 kg/mt)
W50M04 MÜLYON PROFİLİ

550-1203 (2,288 kg/mt)
W50M03 MÜLYON PROFİLİ

550-1202 (2,015 kg/mt)
W50M02 MÜLYON PROFİLİ

550-1201 (1,821 kg/mt)
W50M01 MÜLYON PROFİLİ

Jx cm⁴

Jy cm⁴

777,39

56,63

458,16

46,57

281,95

37,72

182,43

30,87

111,72

25,99

67,39

21,81

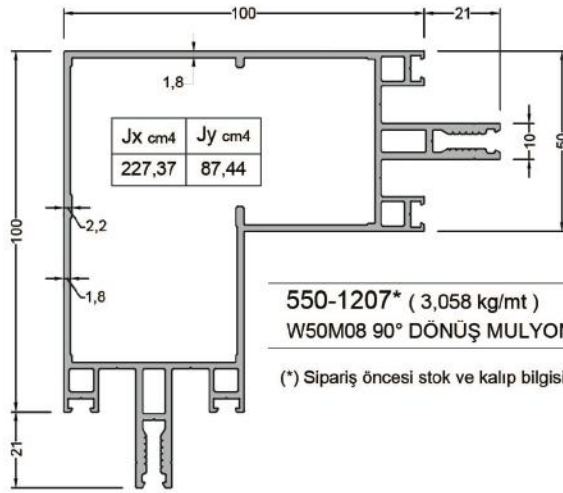
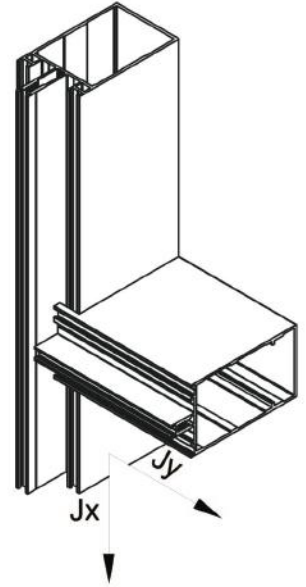

550-1207* (3,058 kg/mt)
W50M08 90° DÖNÜŞ MÜLYON PROFİLİ

(*) Sipariş öncesi stok ve kalıp bilgisi sorulmalı

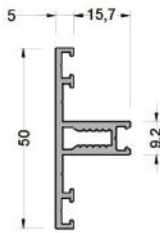

550-2101 (0,547 kg/mt)
W50T07 TRANSOM PROFİLİ

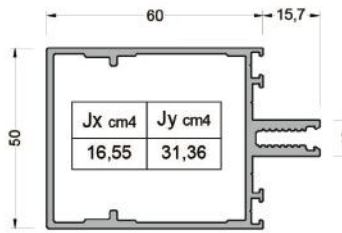

550-2205 (1,300 kg/mt)
W50T21 TRANSOM PROFİLİ

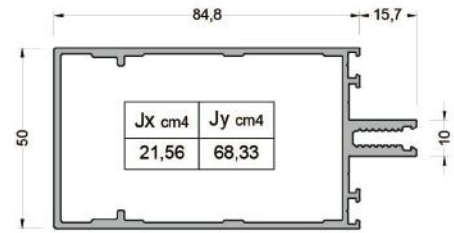

550-2201 (1,518 kg/mt)
W50T17 TRANSOM PROFİLİ

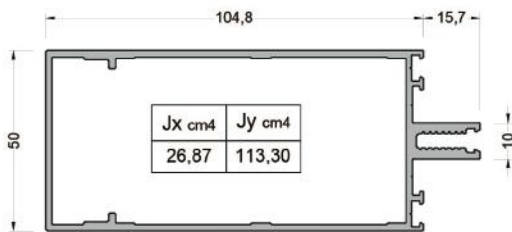

550-2202 (1,871 kg/mt)
W50T18 TRANSOM PROFİLİ

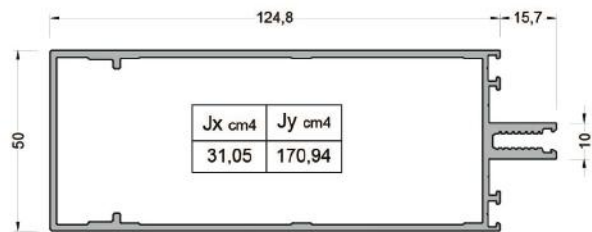

550-2203 (2,066 kg/mt)
W50T19 TRANSOM PROFİLİ

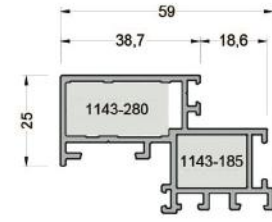
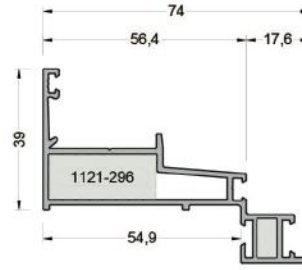
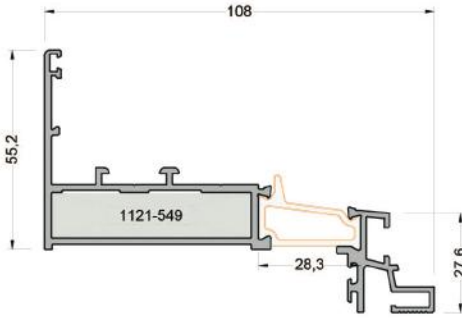
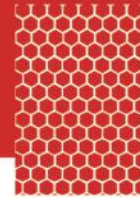

550-3102 (1,706 kg/mt)
W50F05 YALITIMLI KASA PROFİLİ

550-3101 (0,975 kg/mt)
W50F04 KASA PROFİLİ

550-4101 (0,970 kg/mt)
W50V09 KASET PROFİLİ

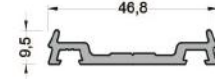
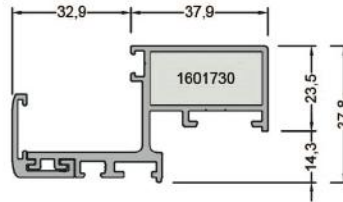
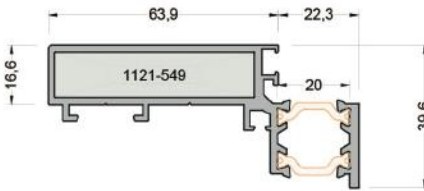

550-6101 (0,425 kg/mt)
W50P01 BASKI PROFİLİ

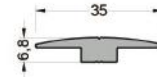

550-4104 (1,517 kg/mt)
W50V12 YALITIMLI KANAT PROFİLİ

550-4202 (1,226 kg/mt)
W50V07 BONDİNGSİZ KASET PROFİLİ

550-6102 (0,316 kg/mt)
W50P12 CAM GÜVENLİK KAPAĞI

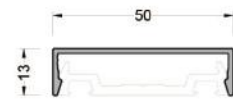
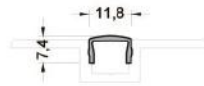
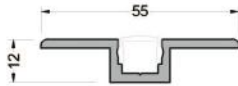

550-6103 (0,494 kg/mt)
W50P09 KAPAK PROFİLİ 3 mm

550-6208 (0,041 kg/mt)
W5009A KAPAMA PROFİLİ

550-6201 (0,277 kg/mt)
W50P03 KAPAK PROFİLİ 13 mm

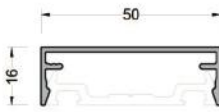
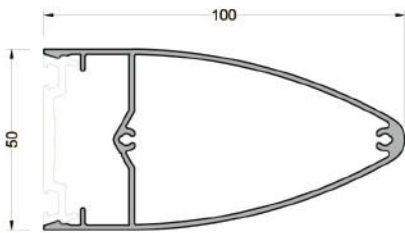

550-6202 (0,330 kg/mt)
W50P04 KAPAK PROFİLİ 16 mm

550-6203 (0,359 kg/mt)
W50P05 KAPAK PROFİLİ 20 mm

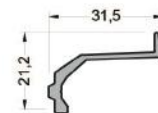

550-6204 (1,134 kg/mt)
W50P08 KAPAK PROFİLİ 100 mm

804-101 (0,110 kg/mt)
IW01 TİJ PROFİLİ

550-9101 (0,296 kg/mt)
W50G12 CAM TAKOZU

550-9103 (0,262 kg/mt)
W50G16 CAM TAKOZU

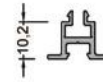

550-5101 (0,134 kg/mt)
W50A01 BONDİNG TİJİ

550-5201 (0,109 kg/mt)
W50G01 ADAPTÖR 8 mm

550-5202 (0,135 kg/mt)
W50G02 ADAPTÖR 12 mm

550-5203 (0,161 kg/mt)
W50G03 ADAPTÖR 16 mm

550-5204 (0,142 kg/mt)
W50G04 ADAPTÖR 10,2 mm

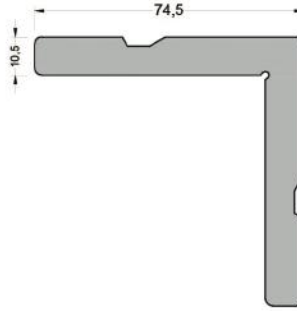
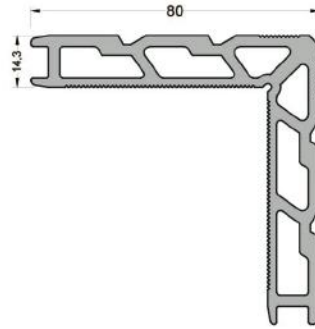
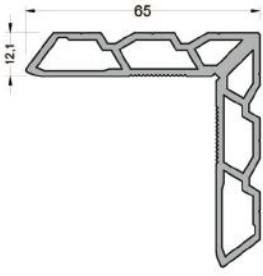
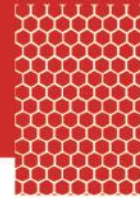

1121 (1,534 kg/mt)
L121 KÖŞE TAKOZU

1143 (2,867 kg/mt)
L143 KÖŞE TAKOZU

1105 (3,855 kg/mt)
L105 KÖŞE TAKOZU

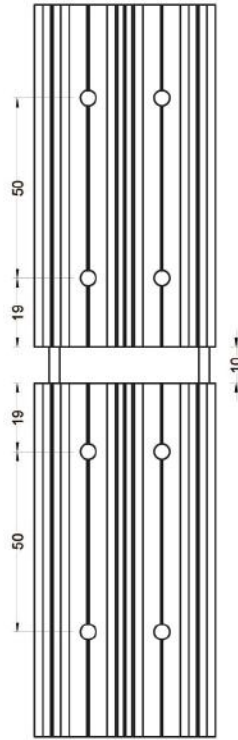
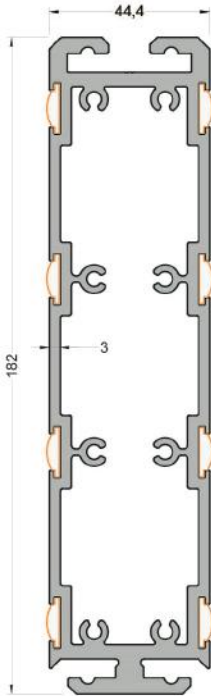

KÖŞE TAKOZU PARÇA KODLARI VE KESİM ÖLÇÜLERİ		
KULLANILAN PROFİL	PARÇA KODU UNIT CODE	KESİM ÖLÇÜSÜ CUTTING SIZE (mm)
550-3102	1121-549	54,9
550-3101	1121-296	29,6
550-3101	1105-050	5,0
550-4101	1143-280	28,0
550-4101	1143-185	18,5
550-4104	1121-549	54,9

MULYON BAĞLANTI KESİM ÖLÇÜSÜ
MULLION JOINT CUTTING SIZES

PROFİL KODU MULLION CODE	Y ÖLÇÜ Y DIMENSION	PARÇA KODU UNIT CODE	KESİM ÖLÇÜSÜ CUTTING SIZE (mm)
550-1201	80 mm	1601064	64,0
550-1202	100 mm	1601084	84,0
550-1203	120 mm	1601103	103,0
550-1204	140 mm	1601123	123,0
550-1205	160 mm	1601141	141,0
550-1207	100 mm	1601084	84,0

550-8101 (5,466 kg/mt)
W50D01 DILATASYON BAĞLANTI PROFİLİ

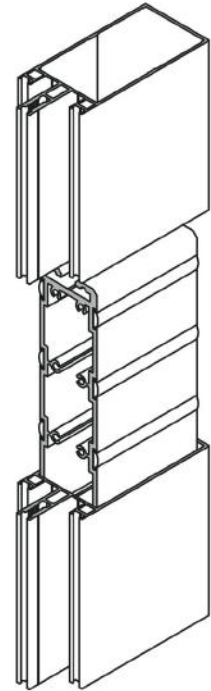
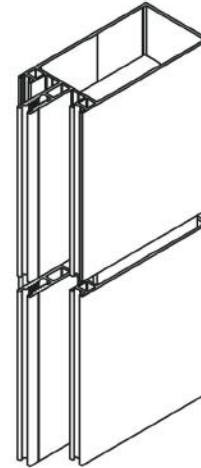

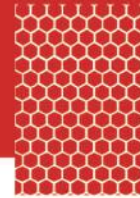

ACCURACY



HARMONY



BALANCE

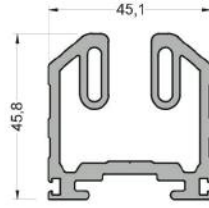

500-7303 (0,272 kg/mt)
F50C03 KIRLANGIÇ KIZAK

550-7301 (1,827 kg/mt)
W50C01 YATAY U BAĞLANTI

500-7302 (1,298 kg/mt)
W50C02 AÇILI BAĞLANTI

KIRLANGIÇ BAĞLANTI KESİM ÖLÇÜLERİ	PARÇA KODU UNIT CODE	KESİM ÖLÇÜSÜ CUTTING SIZE (mm)	GENLEŞME LASTİĞİ DILATATION GASKET
550-2205 (60 LİK YATAY)	1601143	35,0	4103221
550-2201 (84,8 LİK YATAY)	1601122	52,9	4103221
550-2202 (104,8 LİK YATAY)	1601123	72,9	4103221
550-2203 (124,8 LİK YATAY)	1601124	92,9	4103221

YATAY U BAĞLANTI KESİM ÖLÇÜLERİ	PARÇA KODU UNIT CODE	KESİM ÖLÇÜSÜ CUTTING SIZE (mm)	GENLEŞME LASTİĞİ DILATATION GASKET
550-2205 (60 LİK YATAY)	1601144	35,0	4103221
550-2201 (84,8 LİK YATAY)	1601126	52,9	4103221
550-2202 (104,8 LİK YATAY)	1601127	72,9	4103221
550-2203 (124,8 LİK YATAY)	1601128	92,9	4103221

AÇILI BAĞLANTI KESİM ÖLÇÜLERİ	PARÇA KODU UNIT CODE	KESİM ÖLÇÜSÜ CUTTING SIZE (mm)
550-2205 (60 LİK YATAY)	1601145	35,0
550-2201 (84,8 LİK YATAY)	1601118	52,9
550-2202 (104,8 LİK YATAY)	1601119	72,9
550-2203 (124,8 LİK YATAY)	1601120	92,9

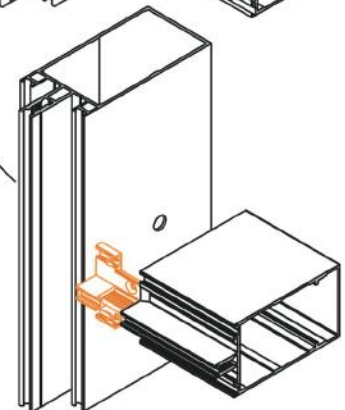
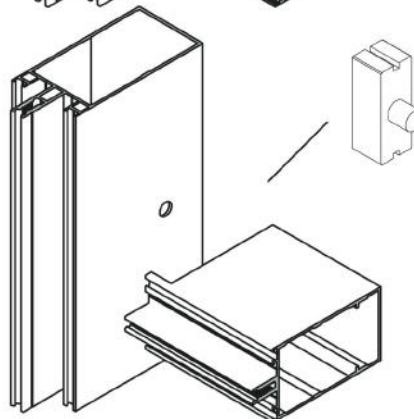
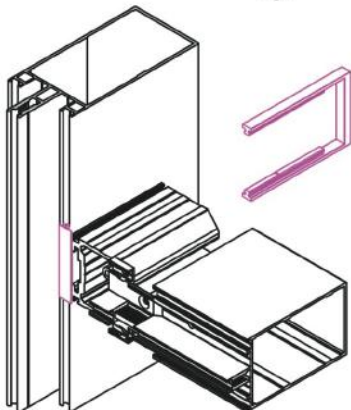
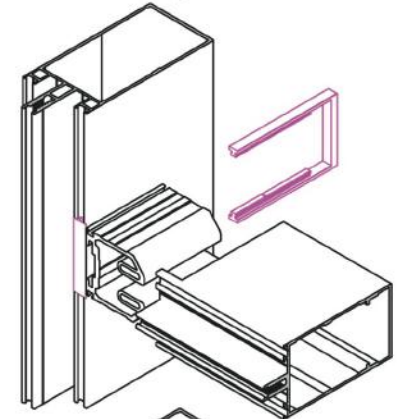
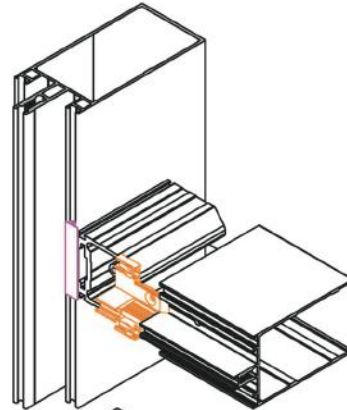
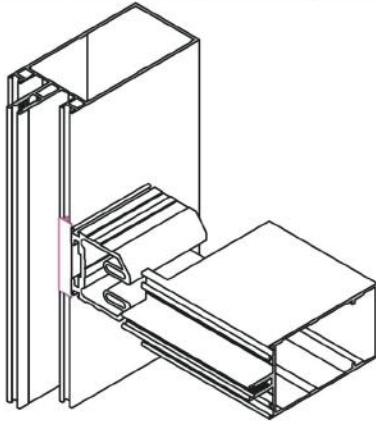
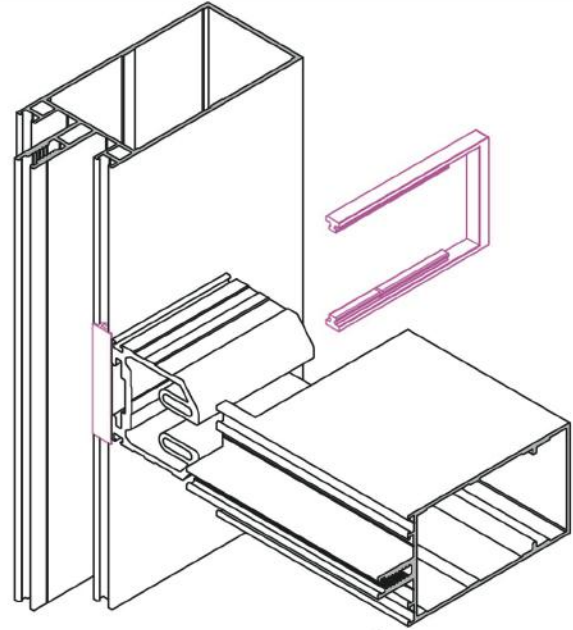

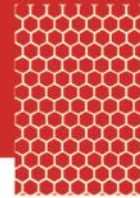

ÜRÜN ÇİZİMİ	ÜRÜN KODU	ÜRÜN ADI	ÜRÜN ÇİZİMİ	ÜRÜN KODU	ÜRÜN ADI	ÜRÜN ÇİZİMİ	ÜRÜN KODU	ÜRÜN ADI
	3202127	İÇ CAM FİTİLİ 2,7 mm		7903112	PVC İZALATÖR 12 mm		0601902	CEPHE AYARLI KARŞILIK 12-115
	3202106	İÇ CAM FİTİLİ 4,7 mm		7903108	PVC İZALATÖR 8 mm		110200	AYARLI KİLİTLEME KARŞILIĞI
	3202107	İÇ CAM FİTİLİ 6,7 mm		4103500	ÇÖRTEN		113000	SMART İLAVE KİLİTLEME VE KARŞILIK
	3202108	İÇ CAM FİTİLİ 8,0 mm		4101501	CWA-P05 DİLASYON U PROFİL 100 mm		113420	KÖŞE HAREKET İLETİM TAKIMI
	3202109	İÇ CAM FİTİLİ 10,7 mm		5303207	CAM TAKOZU 5x25x100 mm		1161-D	SİRİUS EKSENEL KIVRIK CEPHE KOLU
	3202110	İÇ CAM FİTİLİ 12,7 mm		4103219	PVC KERTMESİZ BAĞLANTI 15,5 mm		180100	CEPHE KOL ADAPTÖRÜ
	3202204	DIŞ CAM FİTİLİ 3 mm		4103220	PVC KERTMESİZ BAĞLANTI 22,0 mm		18200	MAKAS YÜKSEKLİK AYAR PARÇASI
	3202113	İÇ CAM FİTİLİ 2-3 mm		4103221	KIRLANGIÇ EPDM FİTİL 65 / 85 / 105 / 125 mm		0518015	CEPHE KANAT GİZLİ TERS BASKI
	3202407	FİTİL KANAT KASA 03G-04		4103215	KÖŞE BAĞLANTI 30,5x15x29 24-105		4016217	CEPHE MAKASI SPT16W (65 kg / 50°)
	3202213	FİTİL SİLİKON ESASLI GİZLİ KANAT KASA 03G-07		1601131	4SU İÇİN TESPİT APARATI İKİLİ		4016222	CEPHE MAKASI SPT22 (100 kg / 45°)
	3202209	GİZLİ KANAT KASA BİNİ FİTİLİ		1601132	4SU İÇİN TESPİT APARATI TEKLİ		4016223	CEPHE MAKASI SPT22W (100 kg / 20°)
	3202307	KANAT BİNİ FİTİLİ		1601401	4S TESPİT İÇİN TEKLİ E02-050		4016226	CEPHE MAKASI SPT26 (180 kg / 20°)
	3202812	ORTA FİTİL		1601951	KASET TESPİT PROFİLİ E01-030		18011	CEPHE MAKAS (STAC) 80 kg
	3202811	KASET DERZ FİTİLİ		8501002	ÇELİK KÖŞE TAKOZU FA-09		18012	CEPHE ÇELİK MAKAS (STAC) 130 kg
	3202205	GİZLİ KANAT KASA BİNİ FİTİLİ		4101020	CAM ARA ÇİTASI 4S		18010	PASLANMAZ CEPHE LİMİTÖR
	3202218	GİZLİ KANAT KASA ÜST DETAY BİNİ FİTİLİ		1607401	CAM ARA U ÇİTA 4SU		0518014	CEPHE MAKASI SINIRLAYICI KOL
	3202214	GİZLİ KANAT KASA FİTİLİ		1601200	KÖŞE GÖNYE		9057G	TEK TARAFLI BANT 10 x 22 mm
	3202210	GİZLİ KANAT KASA FİTİLİ		1601201	KÖŞE GÖNYE		7599050	ALÜMİNYUM FÖİL BANT 1x50 mm
	3202208	GİZLİ KANAT KASA ORTA FİTİLİ		4103404 ÜST	KASET ÜST OTURMA PARÇASI		5303208	PVC CAM TAKOZU
	3202803	DERZ FİTİLİ 10,5 mm 07G-01		4103404 ALT	KASET ALT OTURMA PARÇASI			
	3202212	GİZLİ KANAT KASA BİNİ FİTİLİ (4S İÇİN)		1601739	BUTONLU YATAY KAYIT BAĞLANTI			
	3202111	DESTEK FİTİLİ 05G-010		1501927	TİJ PİMİ CEPHE 15-162			

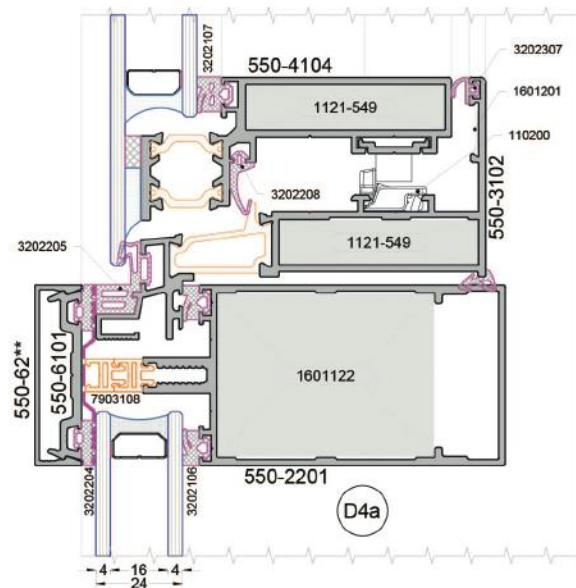
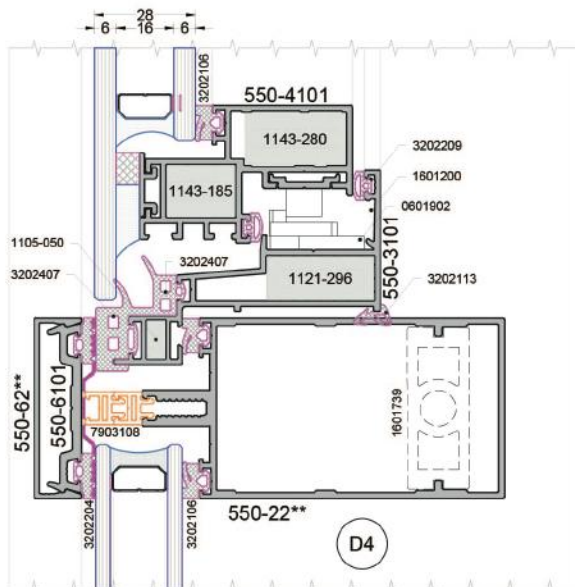
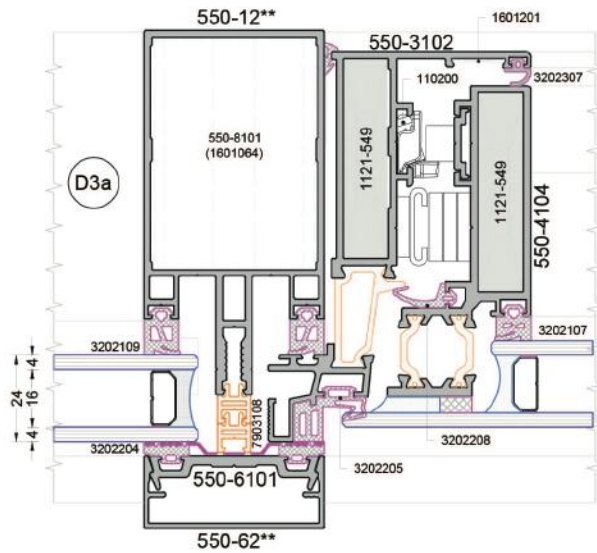
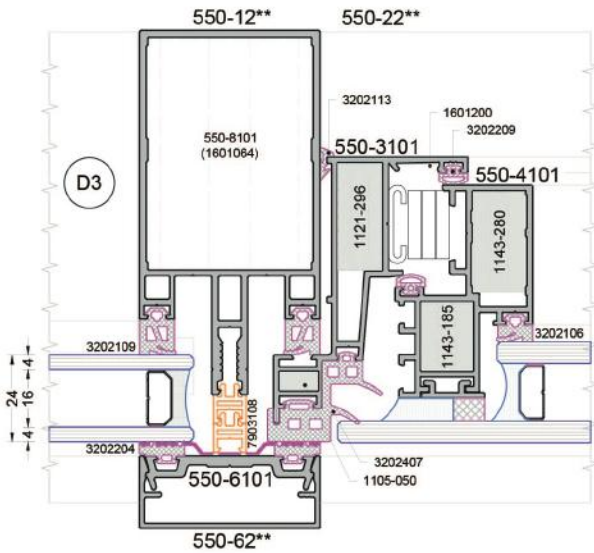
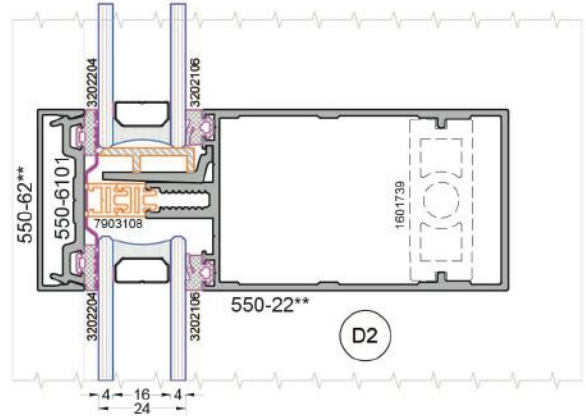
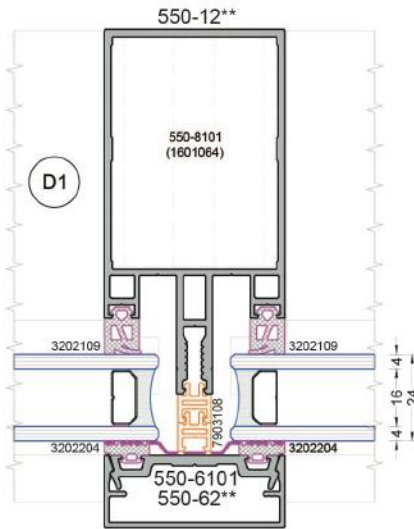
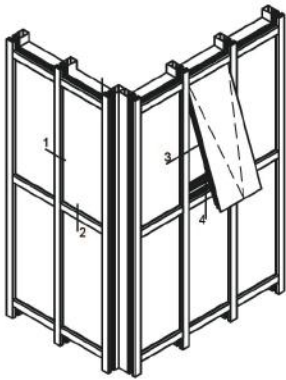
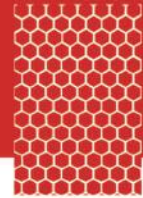

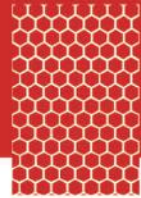

ACCURACY



HARMONY



BALANCE

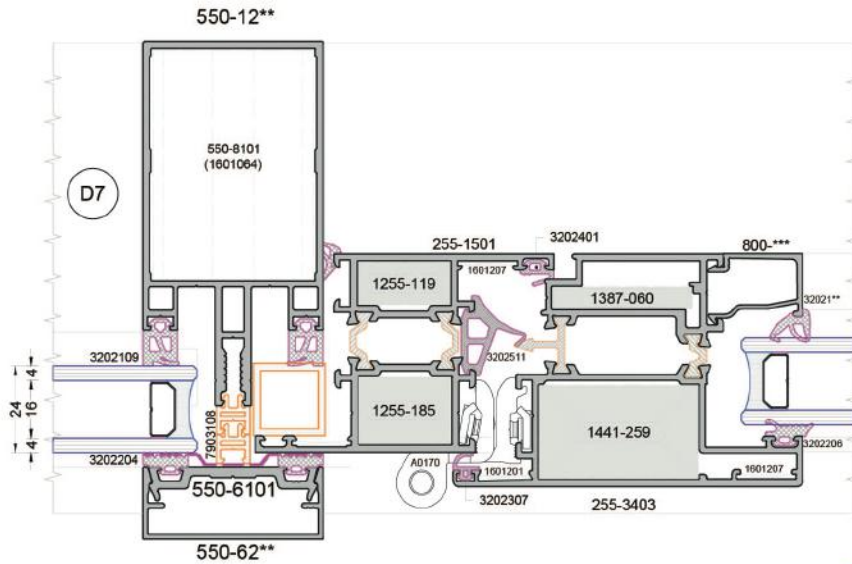
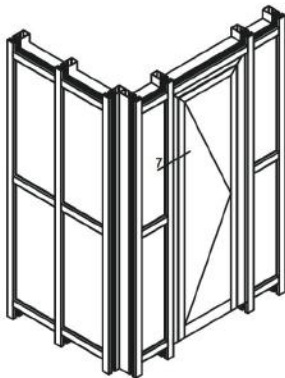
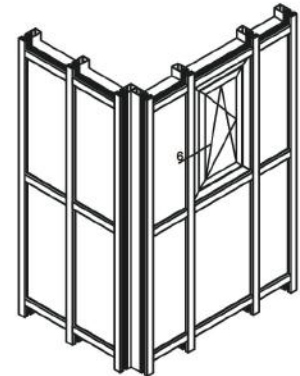
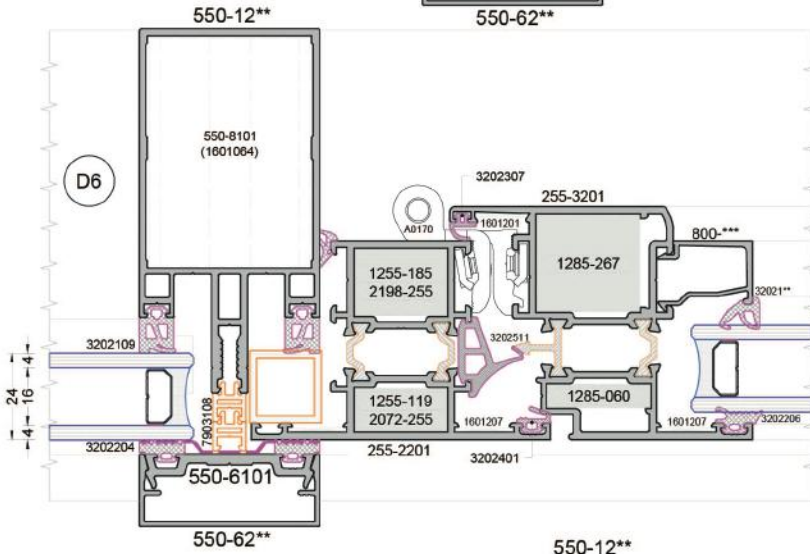
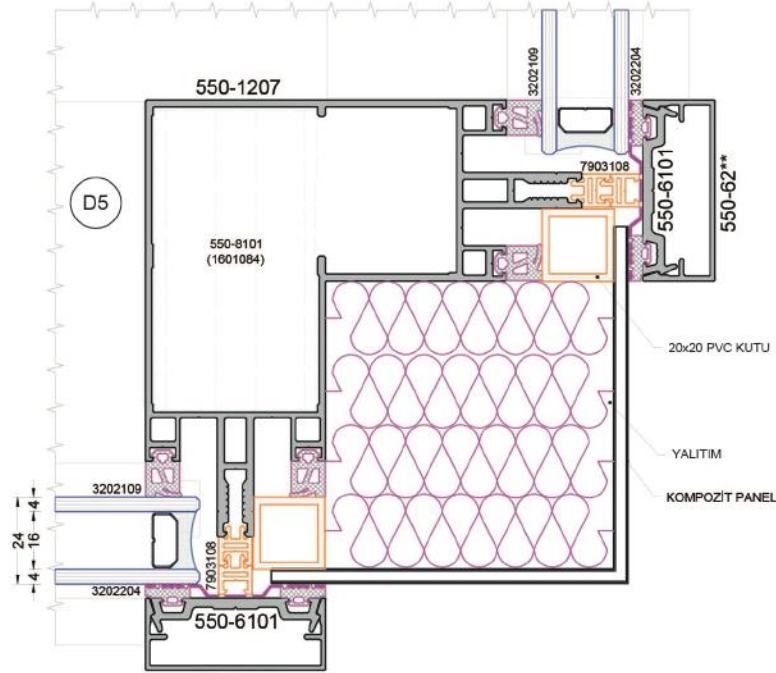
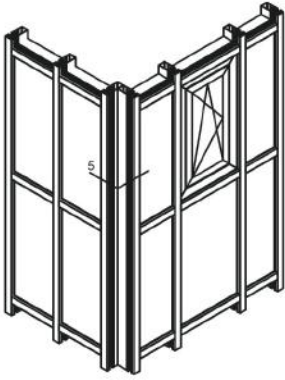



ACCURACY



HARMONY



BALANCE

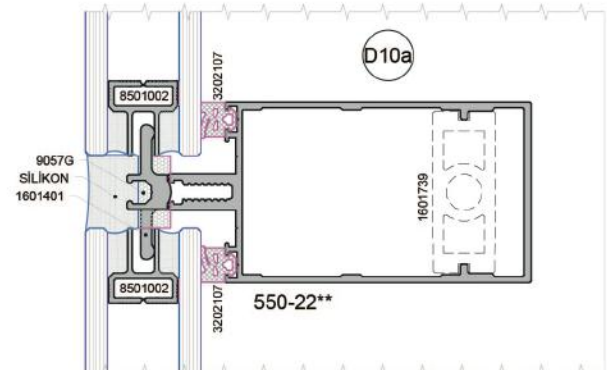
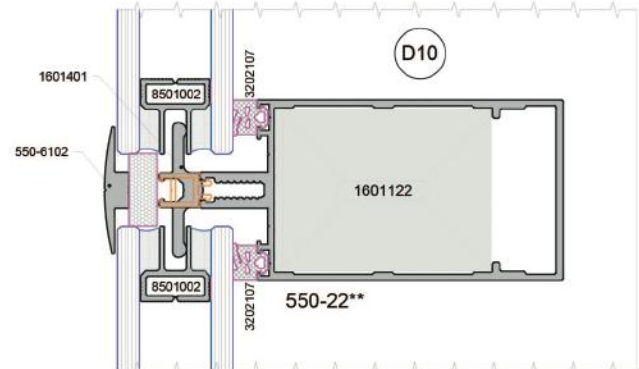
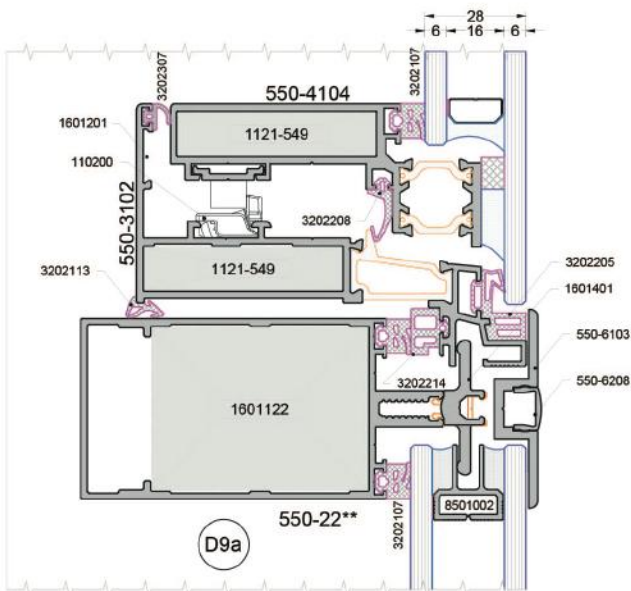
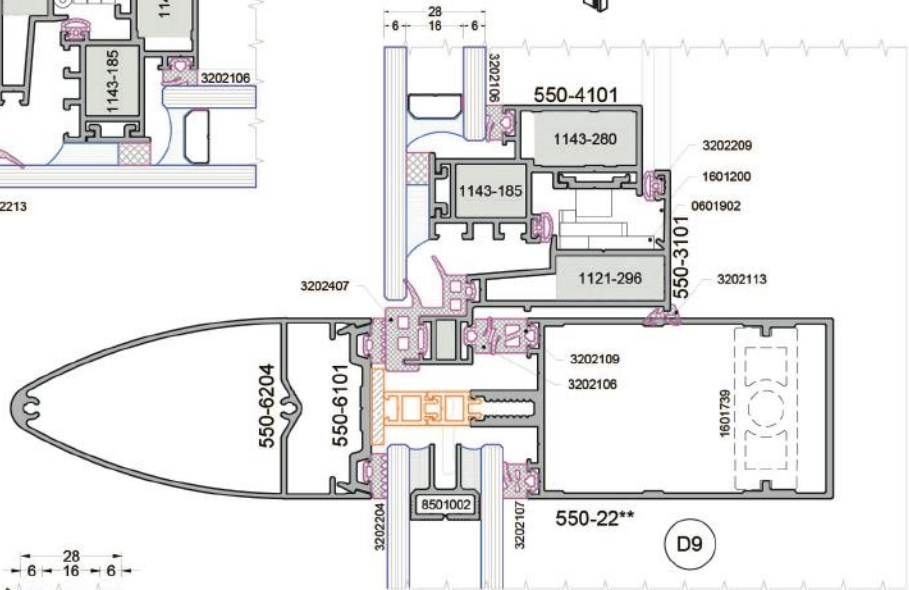
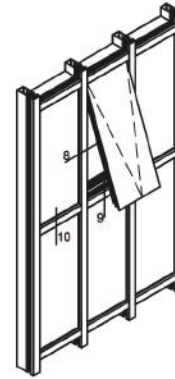
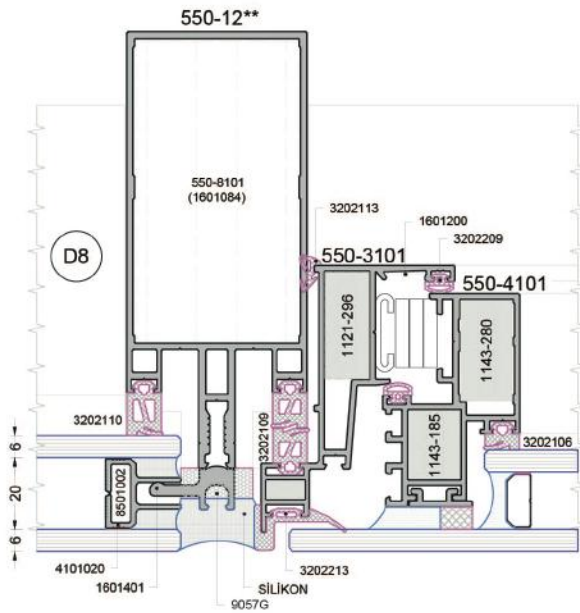

CWA 50 / 4S-U

CEPHE SİSTEMİ



ACCURACY



HARMONY



BALANCE

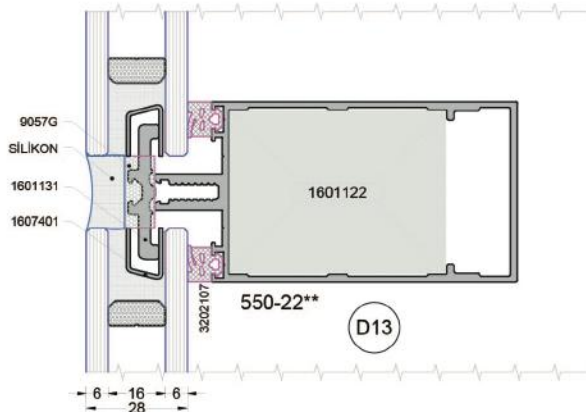
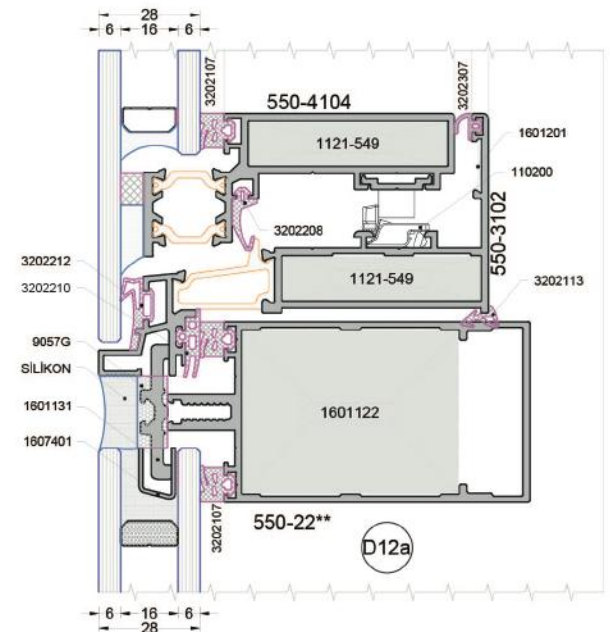
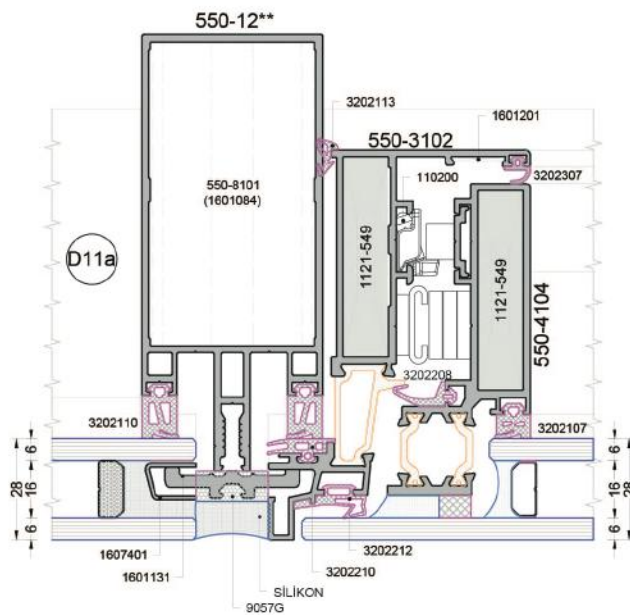
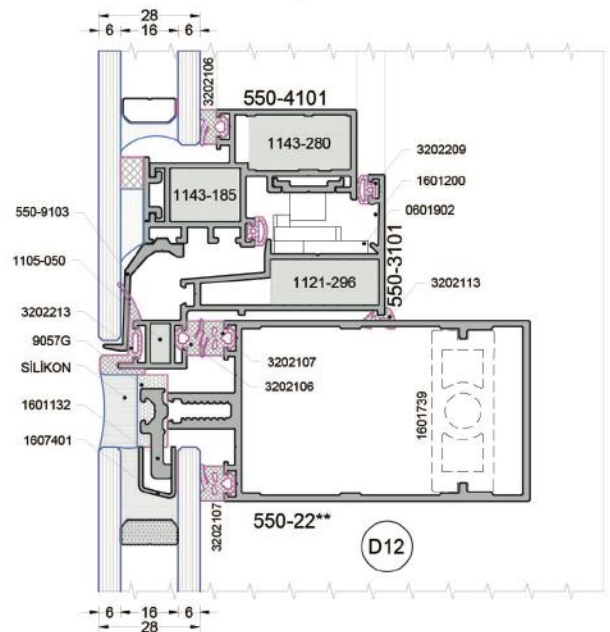
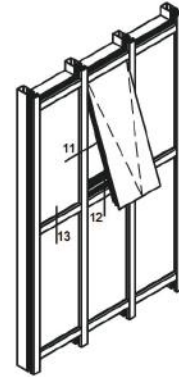
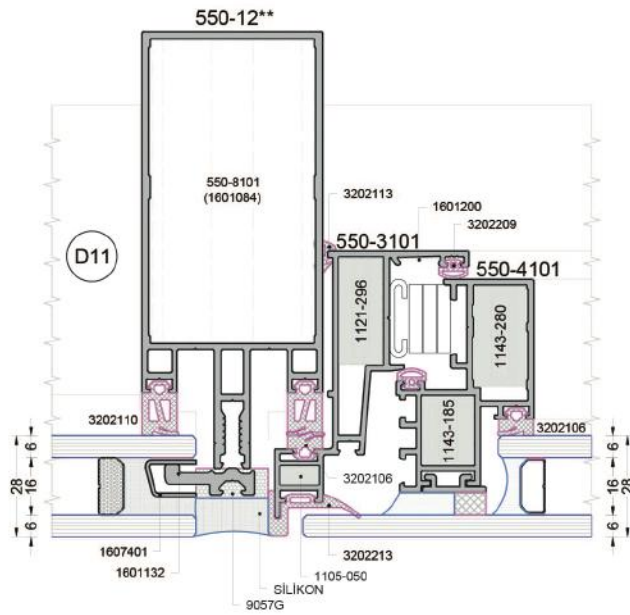

CWA 50 SG

CEPHE SİSTEMİ

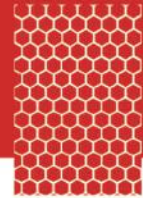

ACCURACY



HARMONY



BALANCE

