

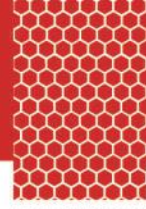

# WAT 63

YALITIMLI KAPI & PENCERE  
SİSTEMİ



ACCURACY

HARMONY

BALANCE

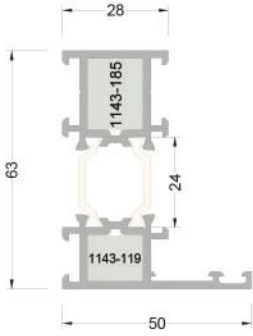

263-1101 ( 1,410 kg/mt )  
T63F01 DAR KASA PROFİLİ

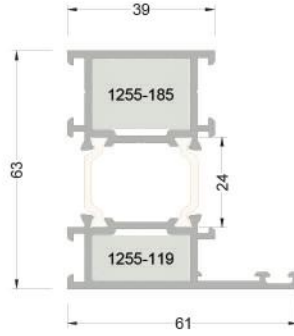

263-1201 ( 1,624 kg/mt )  
T63F02 GENİŞ KASA PROFİLİ

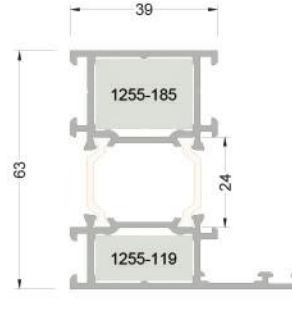

263-1202 ( 1,438 kg/mt )  
T63F12 GENİŞ KASA PROFİLİ

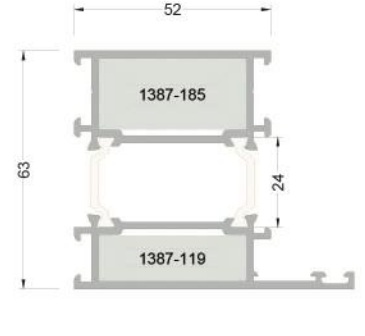

263-1301 ( 1,879 kg/mt )  
T63F03 BAZA KASA PROFİLİ

(\* ) Sipariş öncesi kalıp bilgisi kontrol edilmeli

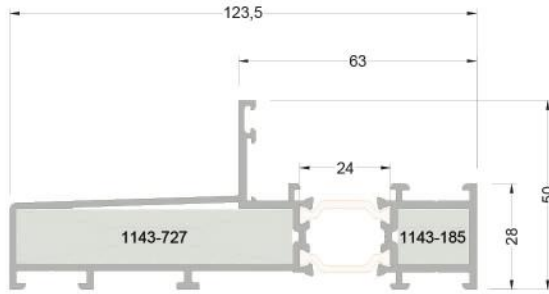

320-1403 ( 1,970 kg/mt )  
ST120F08 SABİT GEÇİŞ KASA PROFİLİ

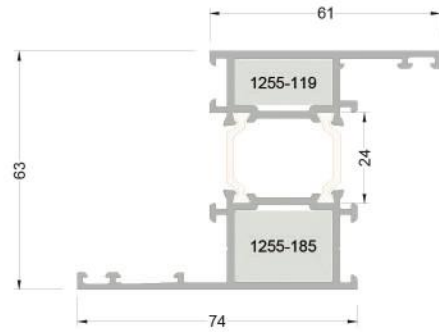

263-1501\* ( 1,820 kg/mt )  
T63F07 PERVAZLI KASA PROFİLİ

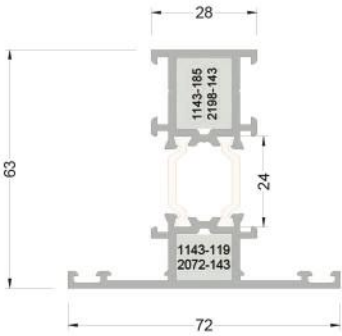

263-2101 ( 1,546 kg/mt )  
T63M01 DAR ORTA KAYIT PROFİLİ

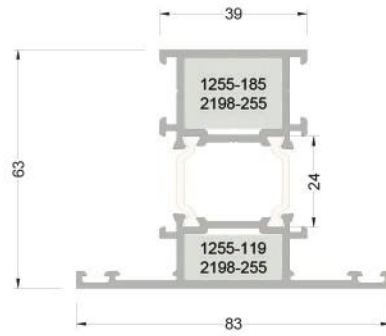

263-2201 ( 1,758 kg/mt )  
T63M03 ORTA KAYIT PROFİLİ

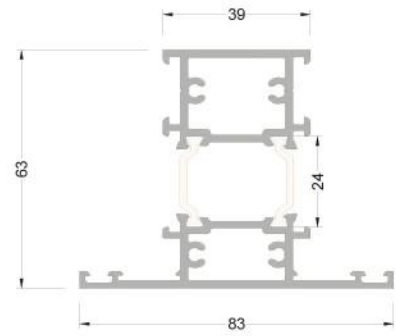

263-2202 ( 1,942 kg/mt )  
T63M04 ORTA KAYIT PROFİLİ VİDALI

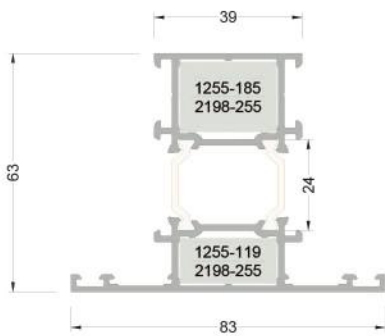

263-2203 ( 1,558 kg/mt )  
T63M13 ORTA KAYIT PROFİLİ

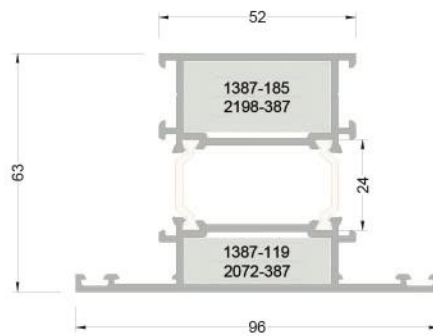

263-2301 ( 1,990 kg/mt )  
T63M05 GENİŞ ORTA KAYIT PROFİLİ

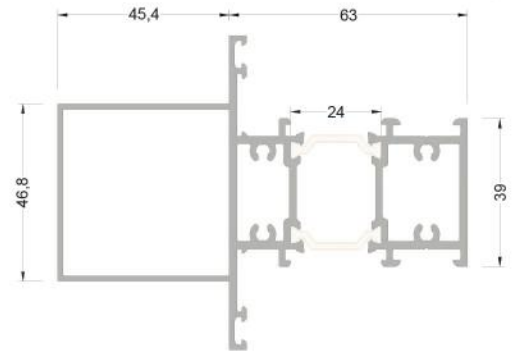

263-2502 ( 2,461 kg/mt )  
T63M09 TAKVİYELİ ORTA KAYIT PROFİLİ

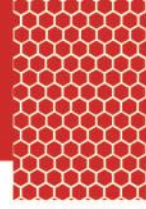

(\*) Sipariş öncesi kalıp bilgisi kontrol edilmeli

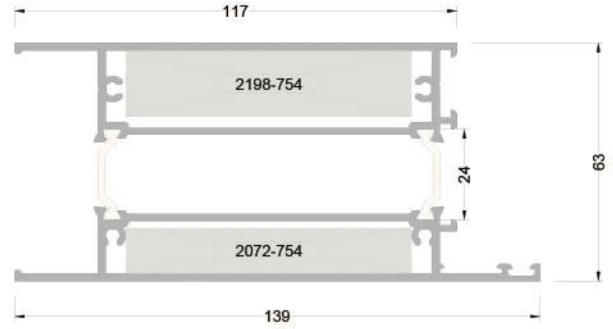
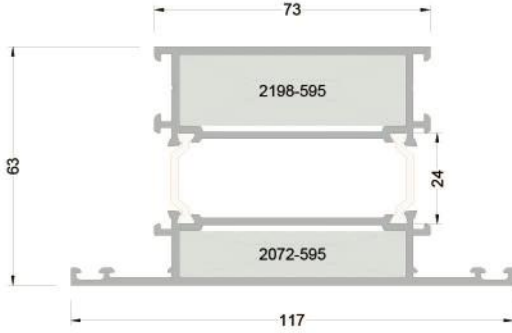

263-2401\* ( 2,470 kg/mt )  
T63M06 BAZA ORTAKAYIT PROFİLİ

263-4401 ( 3,163 kg/mt )  
T63K01 ETEK PROFİLİ

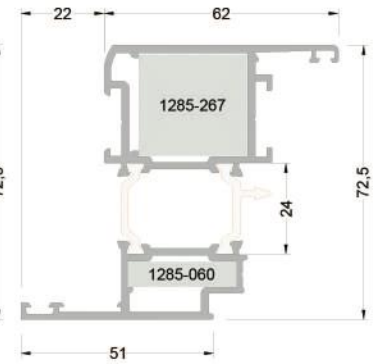
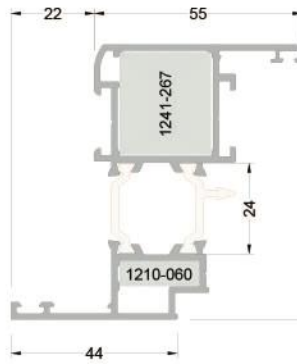
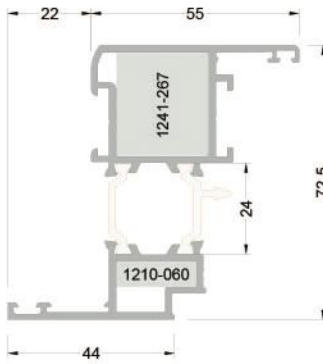
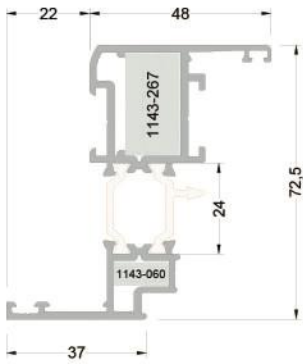

263-3101 ( 1,587 kg/mt )  
T63V01 DAR KANAT PROFİLİ

263-3204 ( 1,682 kg/mt )  
T63V25 KANAT PROFİLİ

263-3205 ( 1,556 kg/mt )  
T63V26 KANAT PROFİLİ

263-3201 ( 1,887 kg/mt )  
T63V03 KANAT PROFİLİ

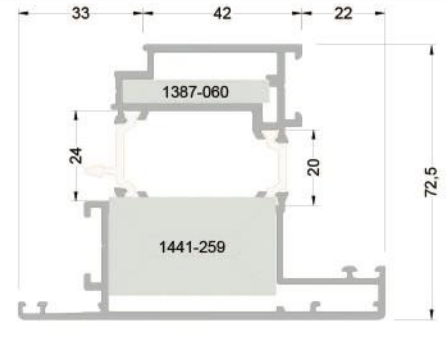
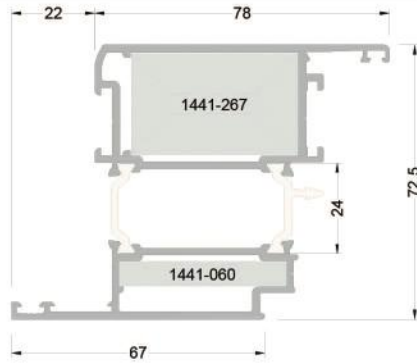
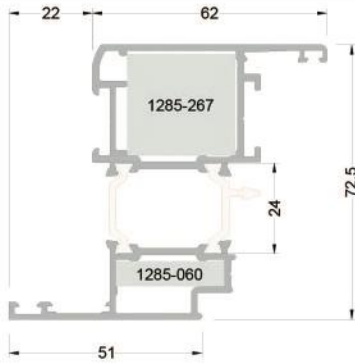

263-3203 ( 1,728 kg/mt )  
T63V13 KANAT PROFİLİ

263-3401 ( 2,223 kg/mt )  
T63V09 KAPI KANAT PROFİLİ

263-3403 ( 2,323 kg/mt )  
T63V11 DIŞ AÇILIM KAPI KANAT PROFİLİ

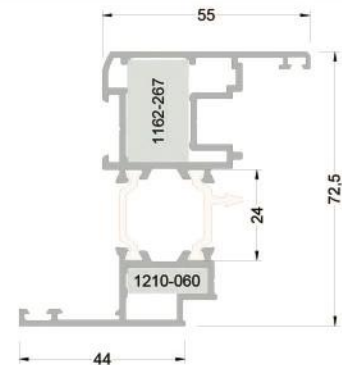
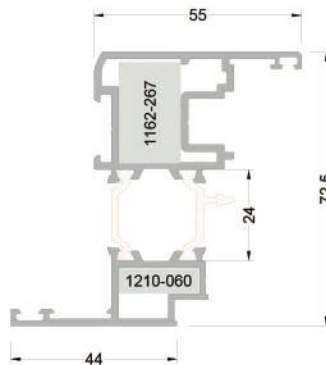
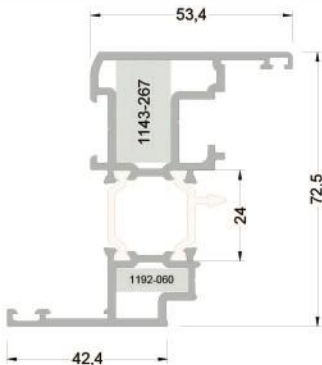

263-3603 ( 1,764 kg/mt )  
T63V17 PVC KANAT PROFİLİ

263-3608 ( 1,779 kg/mt )  
T63V27 PVC KANAT PROFİLİ

263-3609 ( 1,617 kg/mt )  
T55V28 PVC KANAT PROFİLİ

# WAT 63

YALITIMLI KAPI & PENCERE SİSTEMİ



ACCURACY

HARMONY

BALANCE

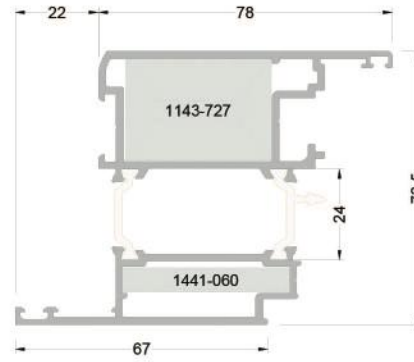
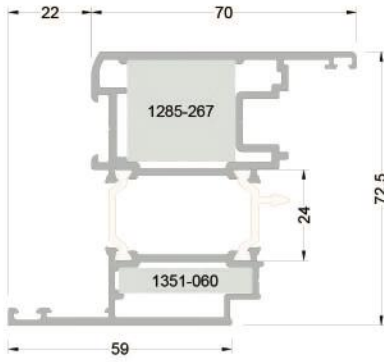

(\*) Sipariş öncesi kalıp bilgisi kontrol edilmeli

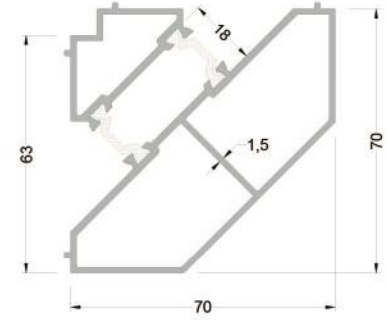

263-3601 ( 2,140 kg/mt )  
T63V05 PVC KANAT PROFİLİ

263-3610 ( 2,220 kg/mt )  
T55V29 PVC KAPI KANAT PROFİLİ

263-5106\* ( 1,789 kg/mt )  
T63A06 90° DÖNÜŞ ADAPTÖR PROFİLİ

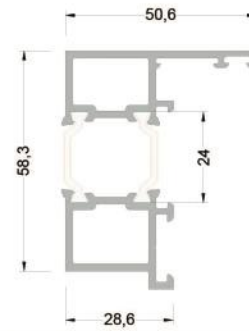
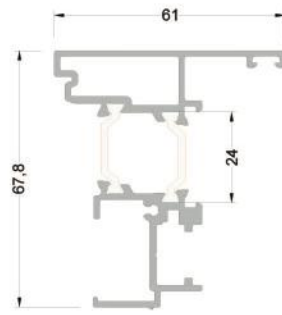
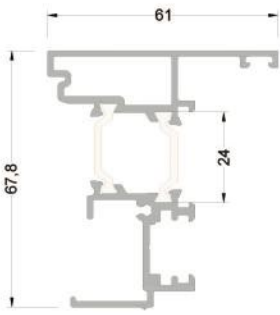

(\*) Sipariş öncesi kalıp bilgisi kontrol edilmeli

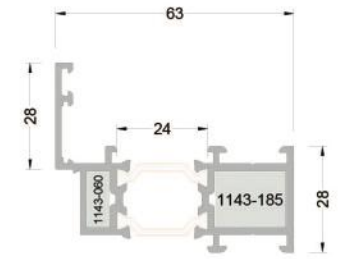

263-5101 ( 1,1400 kg/mt )  
T63A01 ÇİFT KANAT ADPTR PR.

263-5102 ( 1,387 kg/mt )  
T63A02 ÇİFT KANAT ADPTR PR.

263-5103 ( 1,377 kg/mt )  
T63A03 DIŞ AÇILIM ADPTR PR.

263-5105\* ( 1,307 kg/mt )  
T63A05 KANAT İÇİ KANAT ADP.

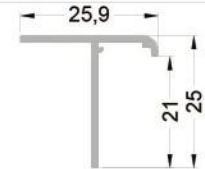
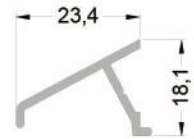
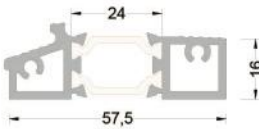

265-4101 ( 1,026 kg/mt )  
T65K03 EŞİK PROFİLİ

804-101 ( 0,110 kg/mt )  
IW01 TİJ PROFİLİ

803-101 ( 0,186 kg/mt )  
P01 DAMLALIK PROFİLİ

802-101 ( 0,185 kg/mt )  
T01 T BİNİ PROFİLİ

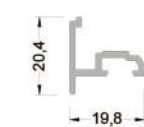
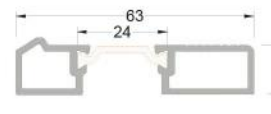
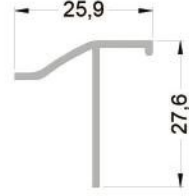
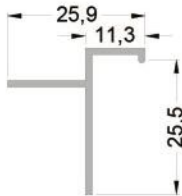

802-102 ( 0,188 kg/mt )  
T02 T BİNİ PROFİLİ

802-103 ( 0,195 kg/mt )  
T03 T BİNİ PROFİLİ

263-5205 ( 0,620 kg/mt )  
T63 A06 EŞİK PROFİLİ

255-5204 ( 0,220 kg/mt )  
WAT55 A05 EŞİK BİNİ PROFİLİ

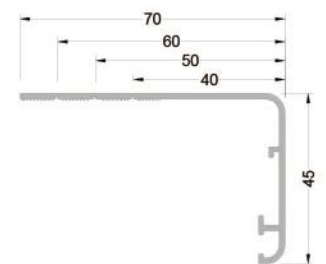
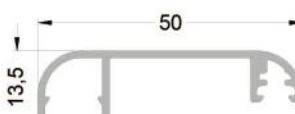
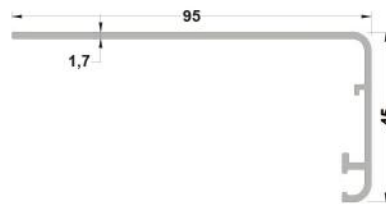
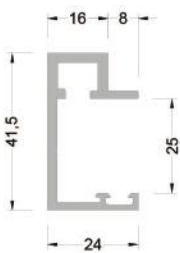

AS-8255 ( 0,681 kg/mt )  
CAM KORKULUK DİKME PR.

801-140 ( 0,605 kg/mt )  
AW14 PERVAZ PROFİLİ

801-135 ( 0,357 kg/mt )  
AW12 PERVAZ PROFİLİ

801-070 ( 0,525 kg/mt )  
AW13 PERVAZ PROFİLİ



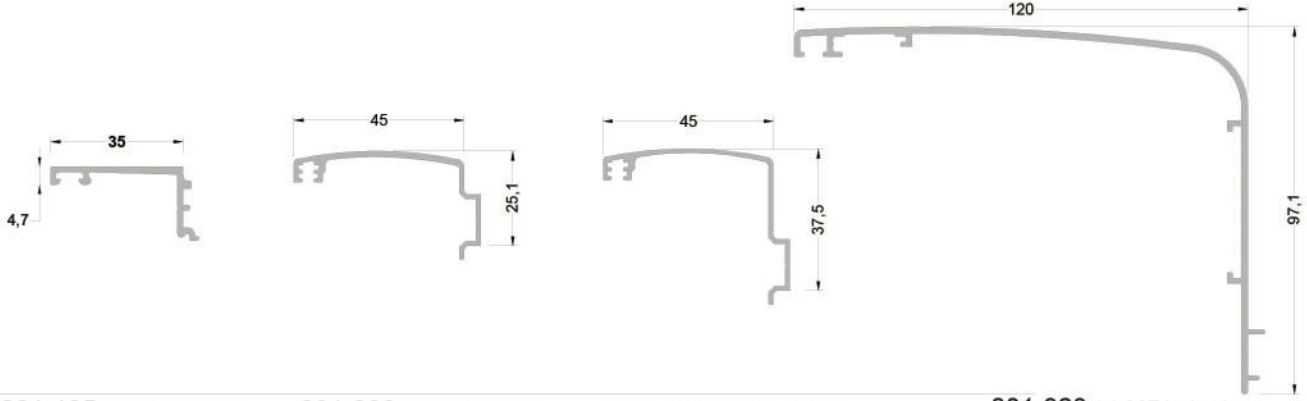

801-195 ( 0,293 kg/mt )  
AW01 PERVAZ PROFİLİ

801-288 ( 0,377 kg/mt )  
AW02 PERVAZ PROFİLİ

801-410 ( 0,343 kg/mt )  
AW03 PERVAZ PROFİLİ

801-923 ( 1,087 kg/mt )  
AW10 PERVAZ PROFİLİ

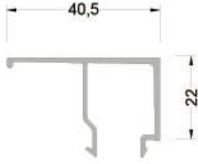

800-405 ( 0,340 kg/mt )  
G405 CAM ÇİTASI

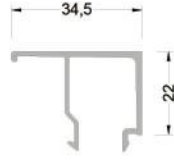

800-345 ( 0,320 kg/mt )  
G345 CAM ÇİTASI

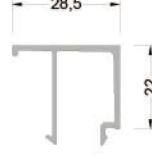

800-285 ( 0,300 kg/mt )  
G285 CAM ÇİTASI

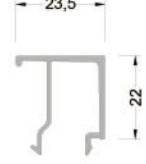

800-235 ( 0,280 kg/mt )  
G235 CAM ÇİTASI

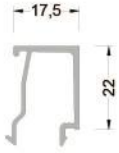

800-175 ( 0,258 kg/mt )  
G175 CAM ÇİTASI

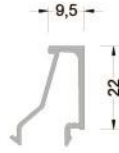

800-095 ( 0,232 kg/mt )  
G095 CAM ÇİTASI



2198 ( 1,170 kg/mt )  
ORTA KAYIT BAĞLANTI PROFİLİ



2072 ( 0,610 kg/mt )  
ORTA KAYIT BAĞLANTI PROFİLİ

### CAM ÇİTASI SEÇİM TABLOSU

CAM ÖLÇÜLERİ ( B )	DIŞ CAM FİTİLİ 3202206 3 mm	İÇ CAM FİTİLLERİ				CAM ÇİTASI ( A )
		3202113 2-3 mm	3202114 4-5 mm	3202115 6-7 mm	3202116 8-9 mm	
8 mm	●			●		800-405
10 mm	●		●			800-405
12 mm	●	●				800-405
16 mm	●		●			800-345
18 mm	●	●				800-345
20 mm	●			●		800-285
22 mm	●		●			800-285
24 mm	●	●				800-285
26 mm	●			●		800-235
28 mm	●		●			800-235
30 mm	●	●				800-235
32 mm	●			●		800-175
34 mm	●		●			800-175
36 mm	●	●				800-175
38 mm	●				●	800-095
40 mm	●			●		800-095
42 mm	●		●			800-095

### ORTA KAYIT BAĞLANTI PROFİLLERİ İÇİN KESİM ÖLÇÜLERİ

PROFİL KODU	PARÇA KODU	KESİM ÖLÇÜSÜ	ORTA KAYIT BAĞLANTI
263-2101	2198-143	14,3 mm	2198
	2072-143	14,3 mm	2072
263-2201	2198-255	25,5 mm	2198
	2072-255	25,5 mm	2072
263-2301	2198-387	38,7 mm	2198
	2072-387	38,7 mm	2072
263-2401*	2198-595	59,5 mm	2198
	2072-595	59,5 mm	2072
263-4401	2198-754	75,4 mm	2198
	2072-754	75,4 mm	2072



# WAT 63

YALITIMLI KAPI & PENCERE SİSTEMİ



ACCURACY

HARMONY

BALANCE

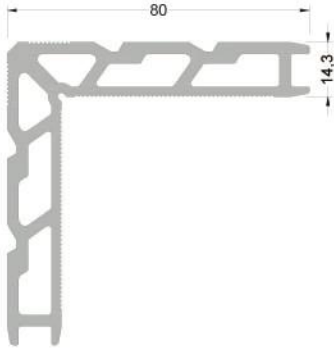

1143 ( 2,867 kg/mt )  
L143 KÖŞE TAKOZU

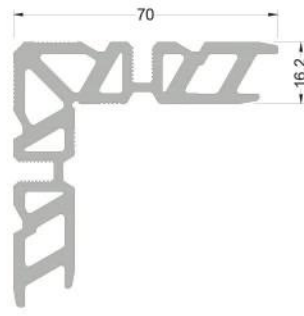

1162 ( 2,783 kg/mt )  
L162 KÖŞE TAKOZU

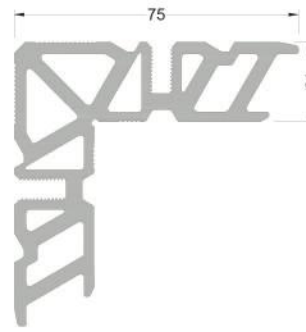

1210 ( 3,449 kg/mt )  
L210 KÖŞE TAKOZU

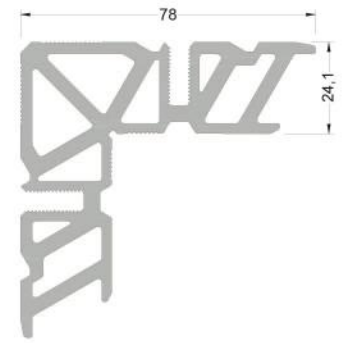

1241 ( 3,799 kg/mt )  
L241 KÖŞE TAKOZU

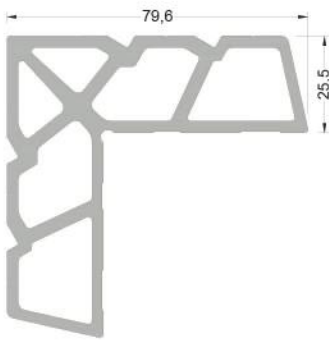

1255 ( 3,490 kg/mt )  
L255 KÖŞE TAKOZU

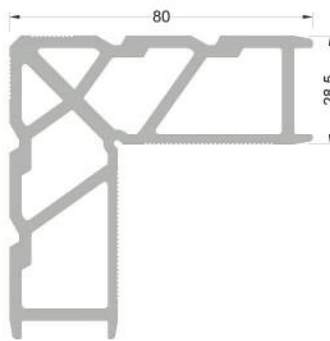

1285 ( 3,511 kg/mt )  
L285 KÖŞE TAKOZU

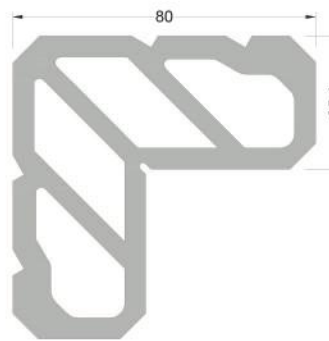

1351 ( 6,000 kg/mt )  
L351 KÖŞE TAKOZU

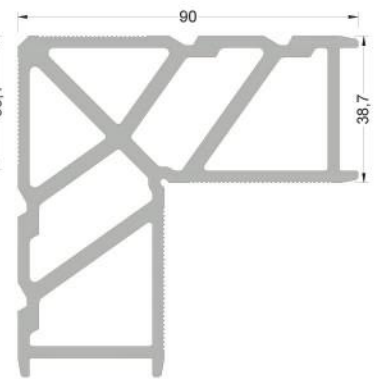

1387 ( 4,924 kg/mt )  
L387 KÖŞE TAKOZU

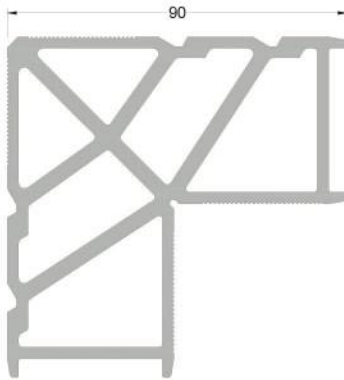

1441 ( 5,116 kg/mt )  
L441 KÖŞE TAKOZU

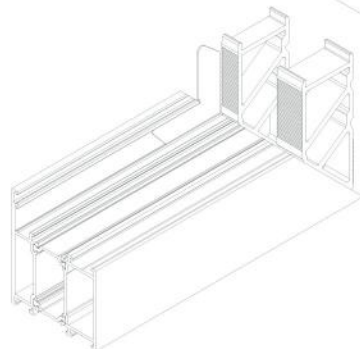
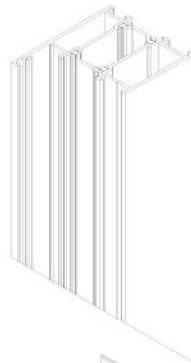

PROFİL KODU	PARÇA KODU	KESİM ÖLÇÜSÜ	KÖŞE TAKOZU
263-1101 263-2101	1143-185	18,5 mm	1143
	1143-119	11,9 mm	
263-1201 / 263-1202 263-2201 / 263-2301	1263-185	18,5 mm	1255
	1263-119	11,9 mm	
263-1301 263-2301	1387-185	18,5 mm	1387
	1387-119	11,9 mm	
320-1404	1143-727	72,7 mm	1143
	1143-185	18,5 mm	
263-1501*	1255-185	18,5 mm	1255
	1255-119	11,9 mm	
263-3102	1143-267	26,7 mm	1143
	1143-060	6,0 mm	
263-3204 263-3205	1241-267	26,7 mm	1241
	1210-060	6,0 mm	
263-3201 263-3203	1285-267	26,7 mm	1285
	1285-060	6,0 mm	
263-3401	1441-267	26,7 mm	1441
	1441-060	6,0 mm	
263-3403	1441-259	25,9 mm	1441 1387
	1387-060	6,0 mm	
263-3604	1143-267	26,7 mm	1143 1192
	1192-060	6,0 mm	
263-3608 263-3609	1162-267	26,7 mm	1162 1210
	1210-060	6,0 mm	
263-3601	1285-267	26,7 mm	1285 1351
	1351-060	6,0 mm	
263-3610	1387-267	26,7 mm	1285 1351
	1441-060	6,0 mm	
263-5104	1285-267	26,7 mm	1285
	1285-060	6,0 mm	
263-5105	1143-185	18,5 mm	1143
	1143-060	6,0 mm	





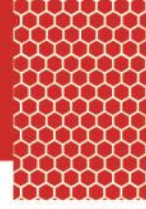

### PENCERE AÇILIM DETAYI

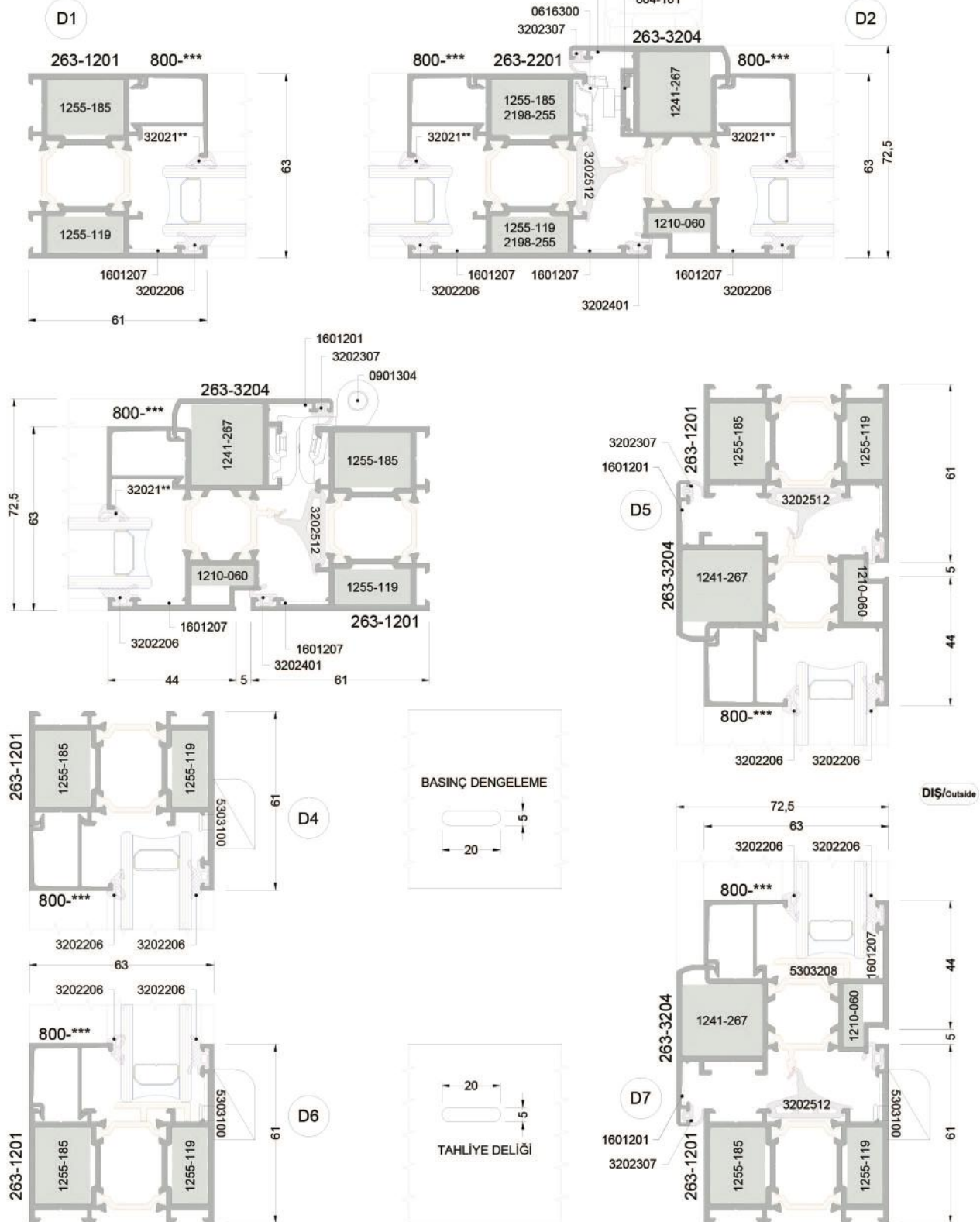
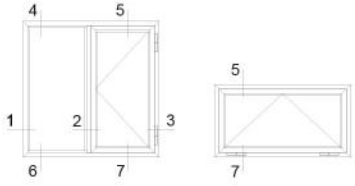



### FRANSIZ BALKON CAM KÜPAŞTE UYGULAMA DETAYI

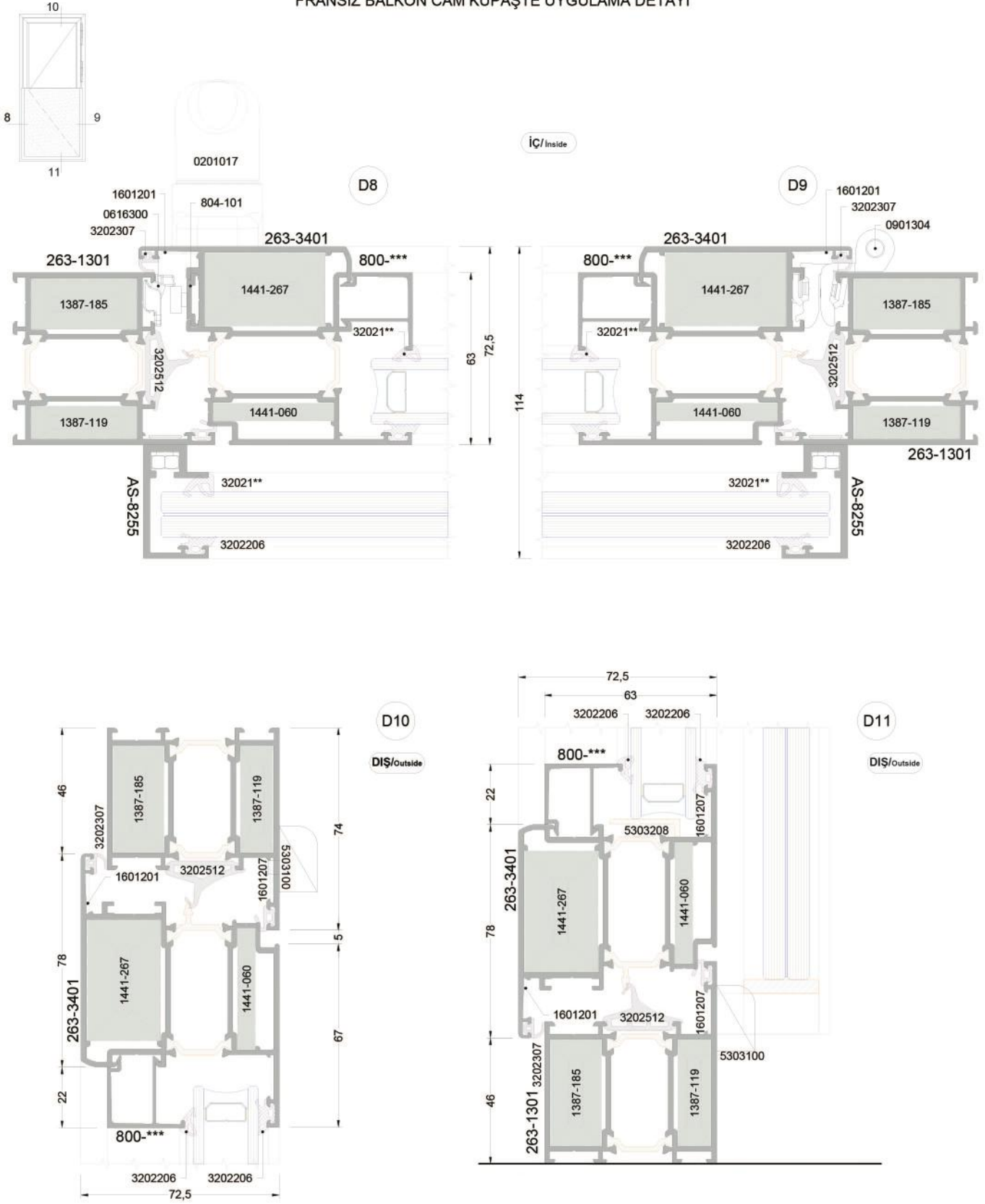



### DIŞ AÇILIM TEK KANAT KAPI DETAYI

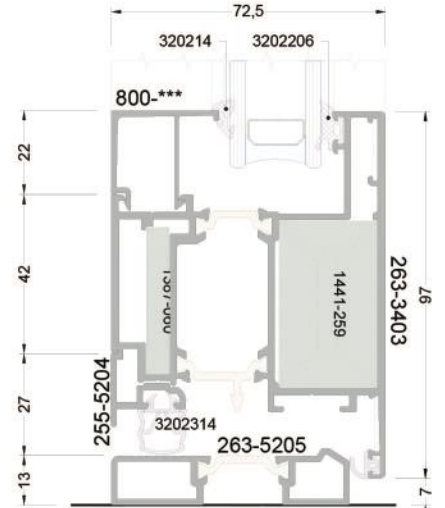
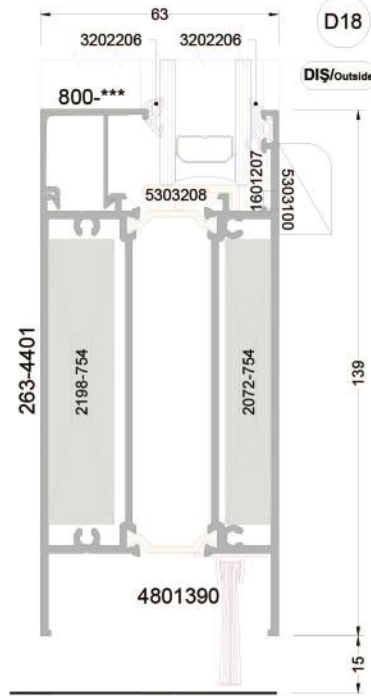
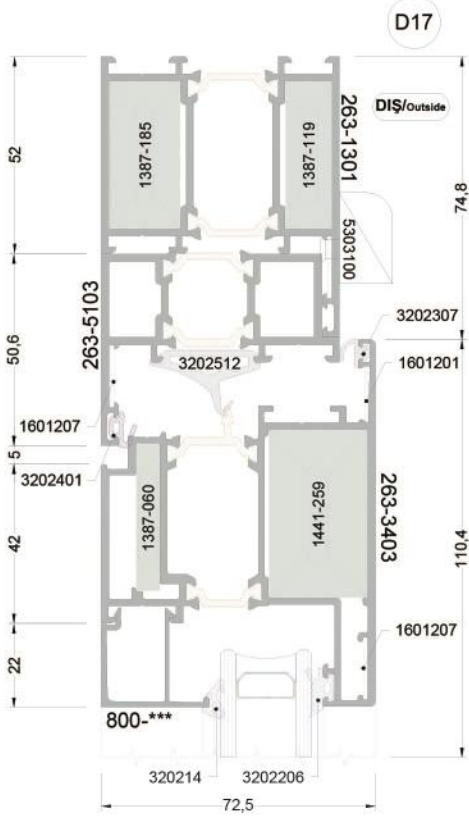
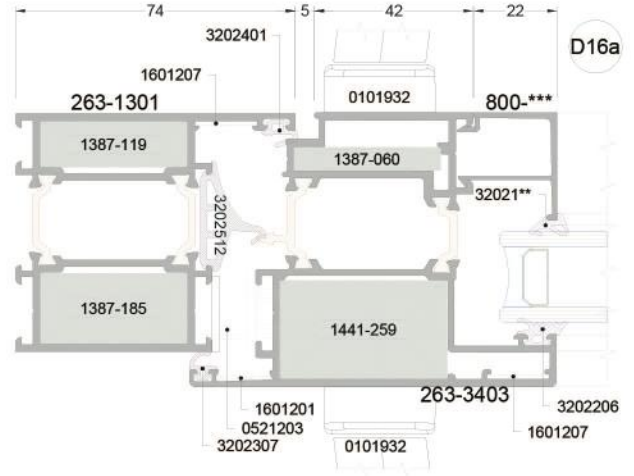
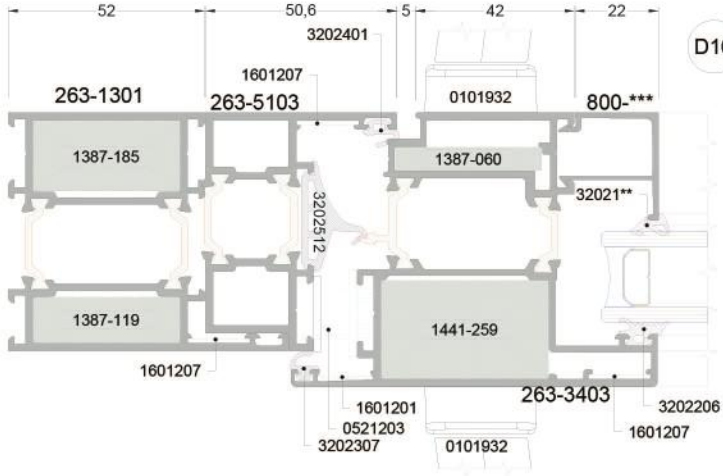
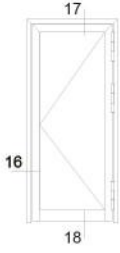



### İÇ AÇILIM ÇİFT KANAT KAPI DETAYI

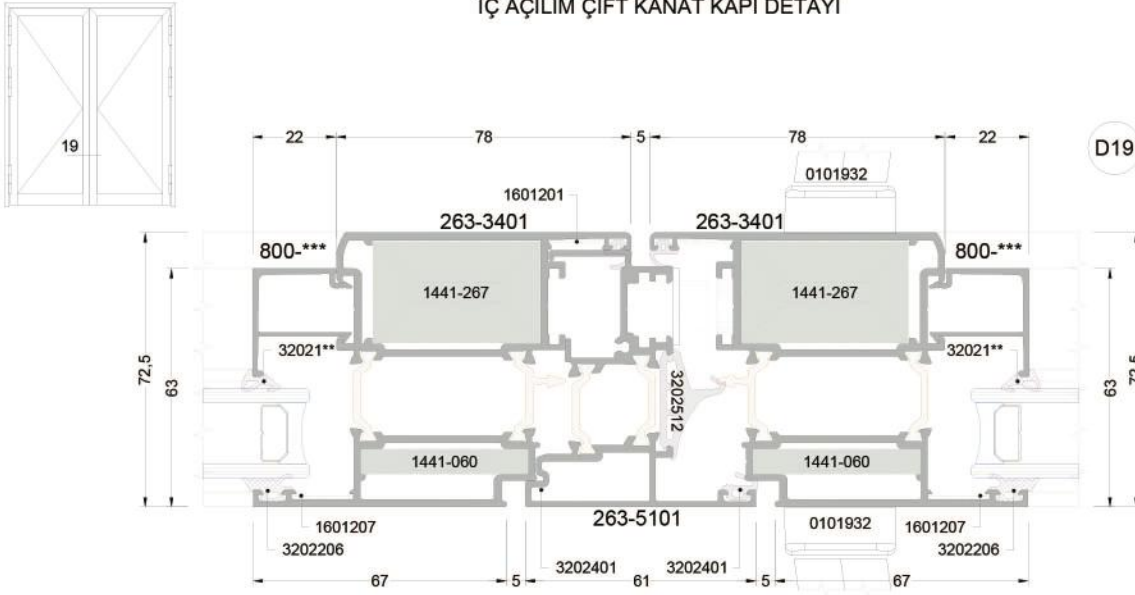

### DIŞ AÇILIM ÇİFT KANAT KAPI DETAYI

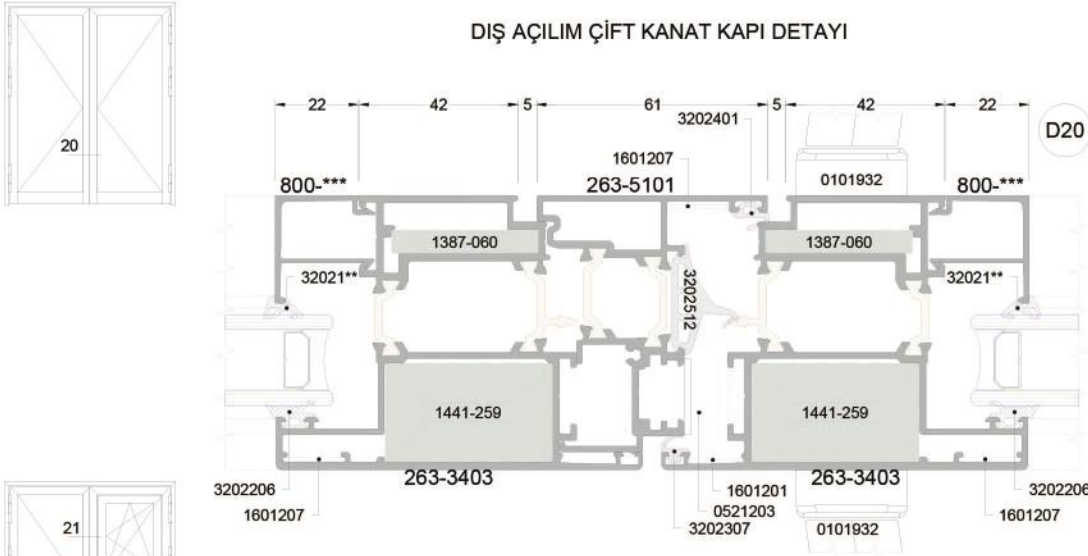

### KANAT İÇİ KANAT DETAYI

