

WA 45

KAPI & PENCERE SİSTEMİ

WA 45

KAPI & PENCERE SİSTEMİ



ACCURACY



HARMONY



BALANCE

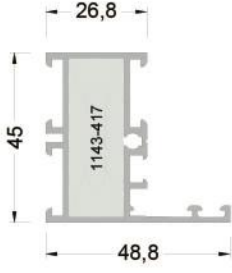

145-1101 (0,818 kg/mt)
WA45F01 DAR KASA PROFİLİ

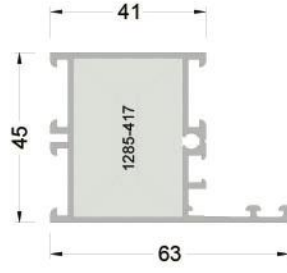

145-1201 (0,925 kg/mt)
WA45F02 KASA PROFİLİ

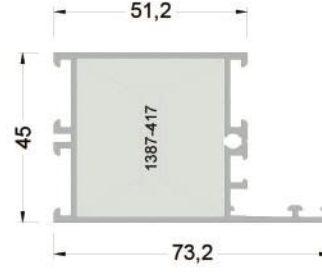

145-1301 (1,003 kg/mt)
WA45F03 GENİŞ KASA PROFİLİ

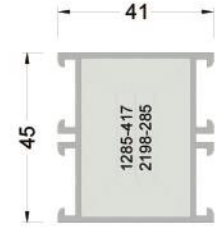

145-1202 (0,784 kg/mt)
WA45F04 KASA PROFİLİ

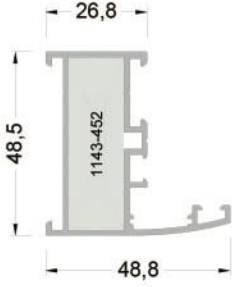

145-1102 (0,786 kg/mt)
WA45F05 DAR KASA PROFİLİ

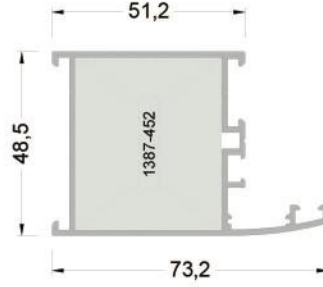

145-1302 (0,971 kg/mt)
WA45F06 GENİŞ KASA PROFİLİ

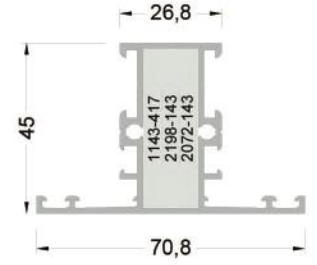

145-2101 (0,959 kg/mt)
WA45M01 DAR ORTA KAYIT PROFİLİ

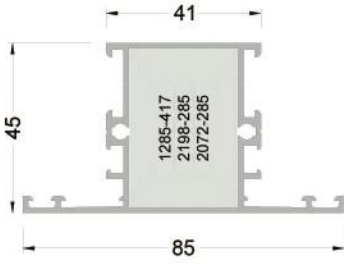

145-2201 (1,076 kg/mt)
WA45M02 ORTA KAYIT PROFİLİ

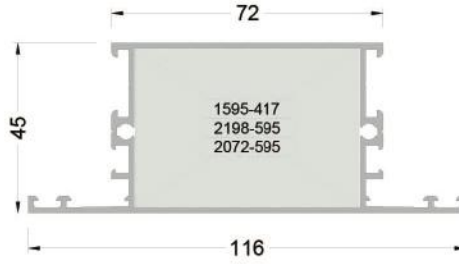

145-2301 (1,302 kg/mt)
WA45M03 BAZA ORTA KAYIT PROFİLİ

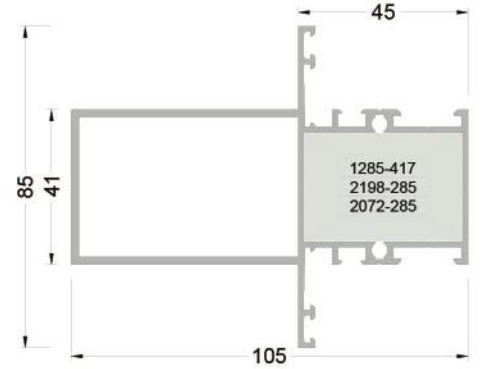

145-2501 (1,918 kg/mt)
WA45M04 TAKVİYELİ ORTA KAYIT PROFİLİ

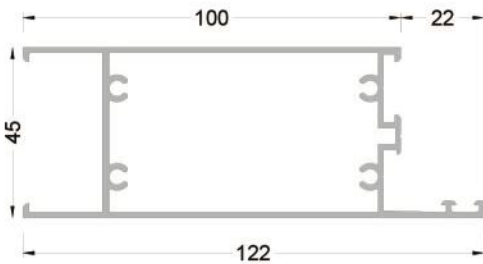

145-4401 (1,500 kg/mt)
WA45K01 ETEK PROFİLİ

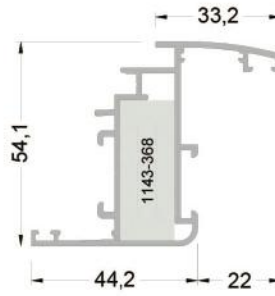

145-3101 (0,951 kg/mt)
WA45V01 DAR KANAT PROFİLİ

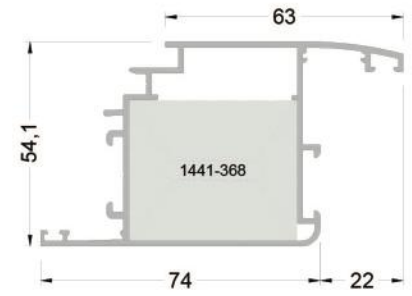

145-3401 (1,209 kg/mt)
WA45V02 KANAT PROFİLİ

WA 45

KAPI & PENCERE SİSTEMİ

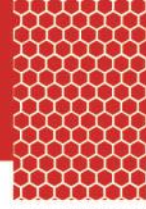

ACCURACY

HARMONY

BALANCE

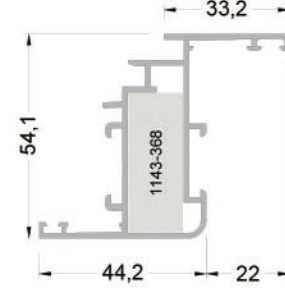
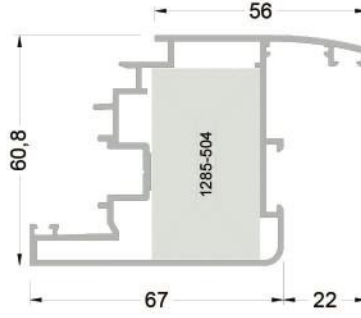
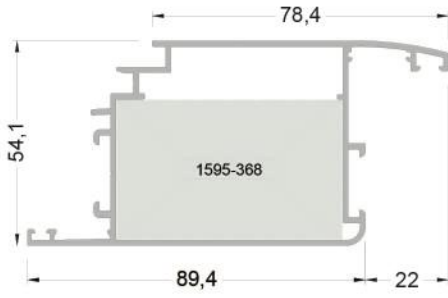

145-3402 (1,330 kg/mt)
WA45V03 İÇ AÇILIR KAPIKANAT PROFİLİ

145-3601 (1,362 kg/mt)
WA45V04 PVC KANAT PROFİLİ

145-3102 (0,940 kg/mt)
WA45V05 DAR KANAT PROFİLİ

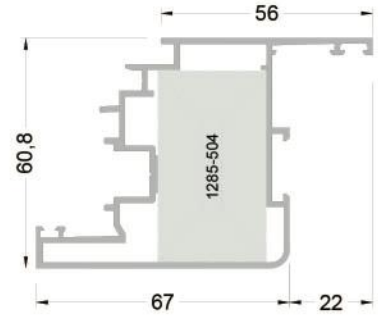
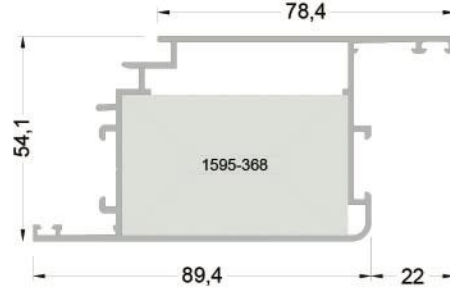
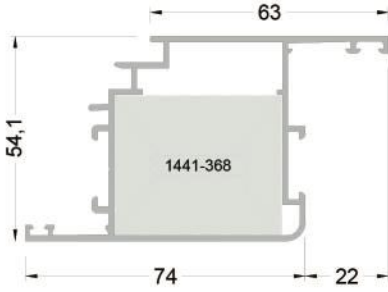

145-3403 (1,199 kg/mt)
WA45V06 GENİŞ KAPI KANAT PROFİLİ

145-3404 (1,321 kg/mt)
WA45V07 BAZA KAPI KANAT PROFİLİ

145-3602 (1,351 kg/mt)
WA45V08 PVC KANAT PROFİLİ

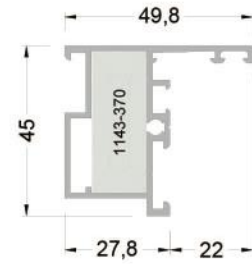
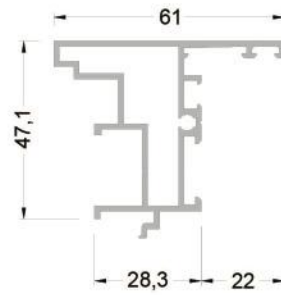
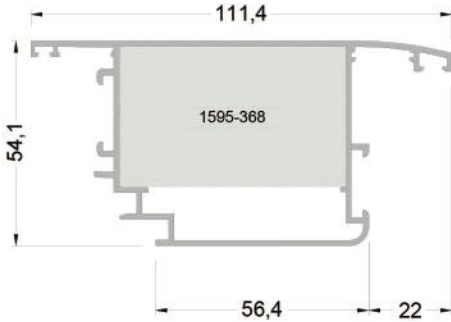

145-3405 (1,319 kg/mt)
WA45V09 DIŞ AÇILIM KAPI KANAT PROFİLİ

145-5101 (1,011 kg/mt)
WA45A01 ÇİFT KANAT ADAPTÖR PROFİLİ

145-5102 (0,771 kg/mt)
WA45A02 DIŞ AÇILIM KANAT ADAPTÖR PROFİLİ

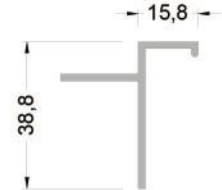
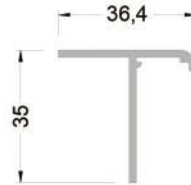
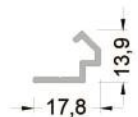
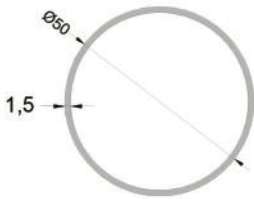

145-5201 (0,619 kg/mt)
WA45C01 EKSENEL DÖNÜŞ

145-5202 (0,135 kg/mt)
WA45C02 DÖNÜŞ ADAPTÖRÜ

802-101 (0,185 kg/mt)
T01 T BİNİ PROFİLİ

802-102 (0,188 kg/mt)
T02 T BİNİ PROFİLİ

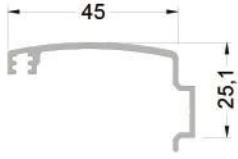

801-288 (0,377 kg/mt)
AW02 PERVAZ PROFİLİ

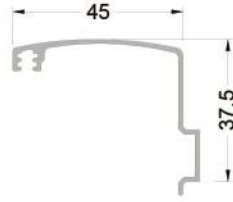

801-410 (0,343 kg/mt)
AW03 PERVAZ PROFİLİ

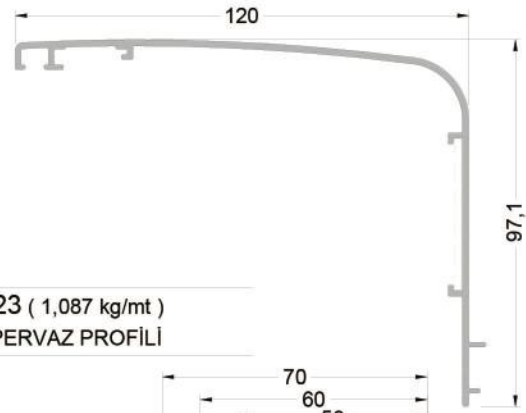

801-923 (1,087 kg/mt)
AW10 PERVAZ PROFİLİ

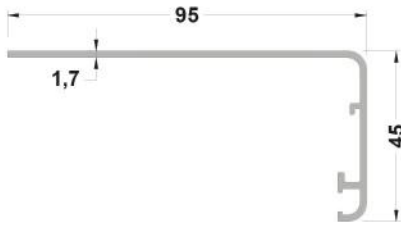

801-140 (0,605 kg/mt)
AW14 PERVAZ PROFİLİ

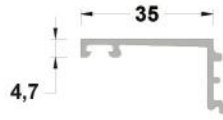

801-195 (0,293 kg/mt)
AW01 PERVAZ PROFİLİ

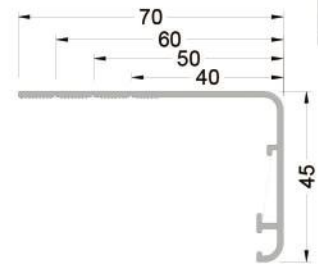

801-070 (0,525 kg/mt)
AW13 PERVAZ PROFİLİ

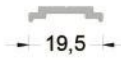

804-101 (0,110 kg/mt)
IW01 TİJ PROFİLİ

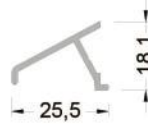

803-101 (0,186 kg/mt)
P01 DAMLALIK PROFİLİ

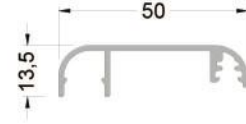

801-135 (0,357 kg/mt)
AW12 PERVAZ PROFİLİ

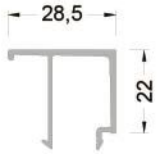

800-285 (0,296 kg/mt)
G285 CAM ÇİTASI

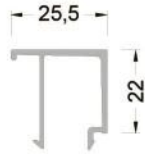

800-255 (0,285 kg/mt)
G255 CAM ÇİTASI

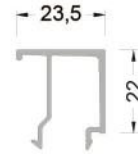

800-235 (0,280 kg/mt)
G235 CAM ÇİTASI

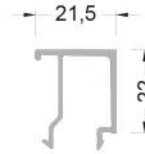

800-215 (0,273 kg/mt)
G215 CAM ÇİTASI

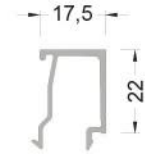

800-175 (0,258 kg/mt)
G175 CAM ÇİTASI

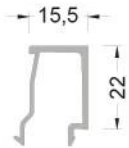

800-155 (0,249 kg/mt)
G155 CAM ÇİTASI

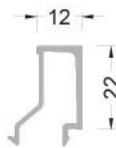

800-120 (0,237 kg/mt)
G120 CAM ÇİTASI

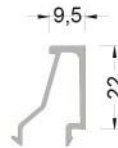

800-095 (0,232 kg/mt)
G095 CAM ÇİTASI



800-045 (0,227 kg/mt)
G045 CAM ÇİTASI

CAM ÇİTASI SEÇİM TABLOSU

CAM ÖLÇÜLERİ	İÇ CAM FITİLERİ			CAM ÇİTASI
	3202206 3 mm	3202113 2-3 mm	3202114 4-5 mm	
6 mm	●	●		800-285
8 mm	●		●	800-255
10 mm	●		●	800-235
12 mm	●		●	800-215
14 mm	●	●		800-215
16 mm	●		●	800-175
18 mm	●		●	800-155

CAM ÇİTASI SEÇİM TABLOSU

CAM ÖLÇÜLERİ	İÇ CAM FITİLERİ			CAM ÇİTASI
	3202206 3 mm	3202113 2-3 mm	3202114 4-5 mm	
20 mm	●	●		800-155
22 mm	●	●		800-120
24 mm	●		●	800-095
26 mm	●	●		800-095
28 mm	●		●	800-045
30 mm	●	●		800-045

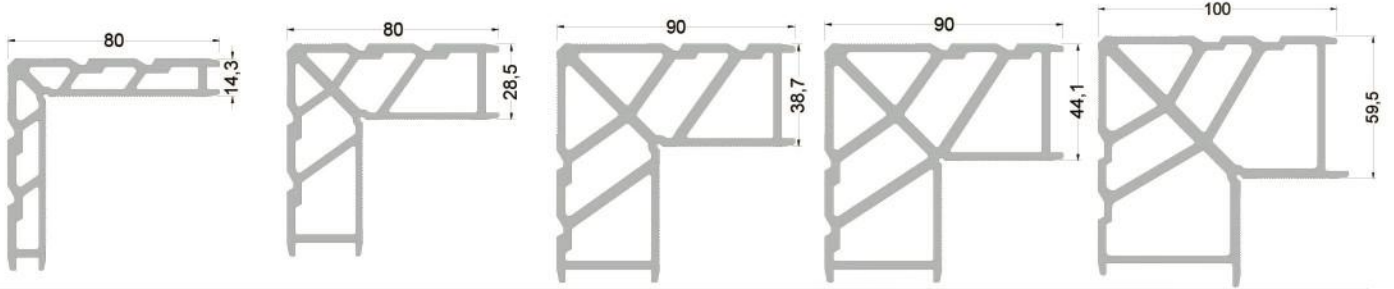

1143 (2,867 kg/mt)
L143 KÖŞE TAKOZU

1285 (3,511 kg/mt)
L285 KÖŞE TAKOZU

1387 (4,924 kg/mt)
L387 KÖŞE TAKOZU

1441 (5,236 kg/mt)
L441 KÖŞE TAKOZU

1595 (5,940 kg/mt)
L595 KÖŞE TAKOZU

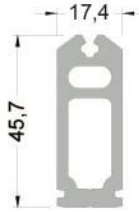

2198 (1,170 kg/mt)
ORTA KAYIT BAĞLANTI PROFİLİ

2072 (0,610 kg/mt)
ORTA KAYIT BAĞLANTI PROFİLİ

KÖŞE TAKOZU KESİM ÖLÇÜLERİ

PROFİL KODU	PARÇA KODU	KESİM ÖLÇÜSÜ	ORTA KAYIT BAĞLANTI
145-1101	1143-417	41,7 mm	1143
145-1201	1285-417	41,7 mm	1285
145-1301	1387-417	41,7 mm	1387
145-1202	1285-417	41,7 mm	1285
145-1102	1143-452	45,2 mm	1143
145-1302	1387-452	45,2 mm	1387
145-2101	1143-417	41,7 mm	1143
145-2201	1285-417	41,7 mm	1285
145-2301	1595-417	41,7 mm	1595
145-3101	1143-368	36,8 mm	1143
145-3401	1441-368	36,8 mm	1441
145-3402	1595-368	36,8 mm	1595
145-3601	1285-504	50,4 mm	1285
145-3102	1143-368	36,8 mm	1143
145-3403	1441-368	36,8 mm	1441
145-3404	1595-368	36,8 mm	1595
145-3602	1285-504	50,4 mm	1285
145-3405	1595-368	36,8 mm	1595
145-5102	1143-370	37,0 mm	1143

ORTA KAYIT BAĞLANTI PROFİLLERİ İÇİN KESİM ÖLÇÜLERİ

PROFİL KODU	PARÇA KODU	KESİM ÖLÇÜSÜ	ORTA KAYIT BAĞLANTI
145-1202	2198-285	28,5 mm	2198
	2072-285	28,5 mm	2072
145-2101	2198-143	14,3 mm	2198
	2072-143	14,3 mm	2072
145-2201	2198-285	28,5 mm	2198
	2072-285	28,5 mm	2072
145-2301	2198-595	59,5 mm	2198
	2072-595	59,5 mm	2072
145-2501	2198-285	28,5 mm	2198
	2072-285	28,5 mm	2072

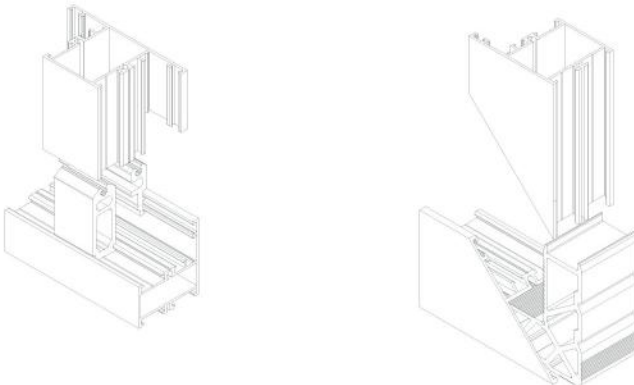

ÜRÜN ÇİZİMİ	ÜRÜN KODU	ÜRÜN ADI
	3202206	DIŞ CAM FİTİLİ 3,0 mm
	3202113	FİTİL DOĞRAMA İÇ CAM 2-3 MM
	3202114	FİTİL DOĞRAMA İÇ CAM 4-5 MM
	3202115	FİTİL DOĞRAMA İÇ CAM 6-7 MM
	3202116	FİTİL DOĞRAMA İÇ CAM 8-9 MM
	3202401	FİTİL DOĞRAMA KASA 03F-01
	3202307	FİTİL DOĞRAMA KANAT 03F-09
	3202503	TOZLUK FİTİLİ
	5303208	PVC CAM TAKOZU
	4801390	FİRÇA ALÜMİNYUM 90 CM
	0901204	SİSTEM MENTEŞE İKİLİ WA-01/A - 10-120
	0901302	SİSTEM MENTEŞE ÜÇLÜ WA-01/B 10-121
	0901205	SİSTEM MENTEŞE İKİLİ WA-02/A 10-122
	0901303	SİSTEM MENTEŞE ÜÇLÜ WA-02/B 10-123
	0901304	SİSTEM PENCERE / KAPI MENTEŞE 90 Kg
	0901207	SİSTEM AĞIR YÜK KAPI MENTEŞE İTHAL 160 Kg
	0901206	SİSTEM KAPI MENTEŞE İTHAL 100 Kg
	0901208	SİSTEM AĞIR YÜK KAPI MENTEŞESİ İKİLİ 160 Kg
	0901305	SİSTEM AĞIR YÜK KAPI MENTEŞESİ ÜÇLÜ 160 Kg
	0901910	AĞIR YÜK MENTEŞE ALT BESLEME APARATI 7 mm
	0901103	PİVOT MENTEŞE WA-03
	0501035	KALE BAREL 86 MM ASİMETRİK 26+10+50
	0521203	35MM DİLLİ DAİRE KİLİT

ÜRÜN ÇİZİMİ	ÜRÜN KODU	ÜRÜN ADI
	0521304	35MM MAKARALI KAPI KİLİT
	0501211	DİLLİ TOROS KİLİT 35*85
	0601104	KARŞILIK KİLİT SİSTEM MAKARALI
	0601006	KARŞILIK KİLİT SİSTEM DİLLİ
	0101932	KAPI KOLU İTHAL
	0101923	KAPI KOLU YERLİ
	0524601	TRANSMİSYON KUTUSU 7MM İTHAL
	0524602	TRANSMİSYON KUTUSU 33,5MM 90 DERECE
	0201017	EKSENEL PENCERE KOLU İTHAL
	0201018	KİLİTLİ EKSENEL PENCERE KOLU İTHAL
	1501929	TIJ PİMİ İZO DOĞRAMA 15-161
	0616300	AYARLANABİLİR KİLİTLEME KARŞILIĞI
	1603400	KANAT KALDIRMA KİTİ
	5016100	KANAT LİMİTÖR KISA
	5016102	KANAT LİMİTÖR UZUN
	5001119	VASİSTAS MAKAS SİSTEM 185 MM
	5001001	VASİSTAS ÇİT ÇİT AMANOS 04-112
	0524603	LEVYE KOLLU ZİT YÖNLÜ KİLİTLEME SETİ
	0701200	SÜRGÜ SİSTEM UZUN
	0701100	SÜRGÜ SİSTEM KISA
	5303003	ÇİFT KANAT ADAPTÖR KAPAĞI
	1601952	TESPİT APARATI
	5303100	TAHLİYE KAPAĞI WA-15

ÜRÜN ÇİZİMİ	ÜRÜN KODU	ÜRÜN ADI
	4801390	FİRÇA ALÜMİNYUM 90 CM
	4801300	FİRÇA ALÜMİNYUM 100 CM
	7803002	PLASTİK U PROFİLİ 40*15 MM YB-P01
	1601200	KÖŞE ÇAVUŞU ALT CL-01
	1601201	KÖŞE ÇAVUŞU ALT CL-02
	1601207	KÖŞE ÇAVUŞU CL-11
	1601217	KÖŞE ÇAVUŞU SQUADRA FUJI 17x4.3
	2016400	SOFT ÇİFT AÇILIM SETİ İTHAL
	2016500	SOFT ÇİFT AÇILIM ÇİFT KANAT AÇILIM SETİ İTHAL
	2016000	ÇİFT AÇILIM SETİ İTHAL
	2016200	ÇİFT AÇILIM ÇİFT KANAT SETİ İTHAL
	2701001	ÇİFT AÇILIM GRUBU GR1- KAVİN 380-680 MM
	2701002	KAVİN ÇİFT AÇILIM GURUBU GR2 640-1200 MM

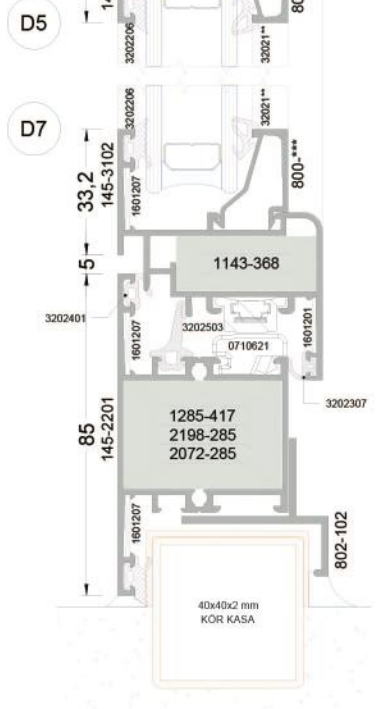
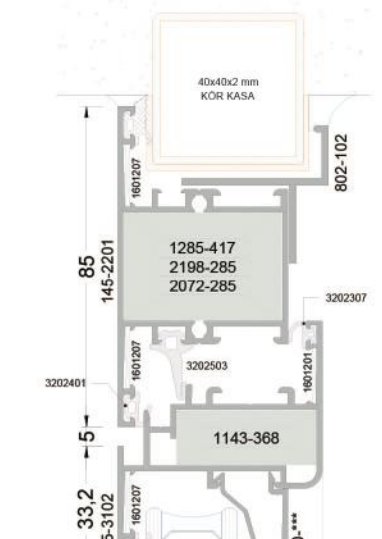
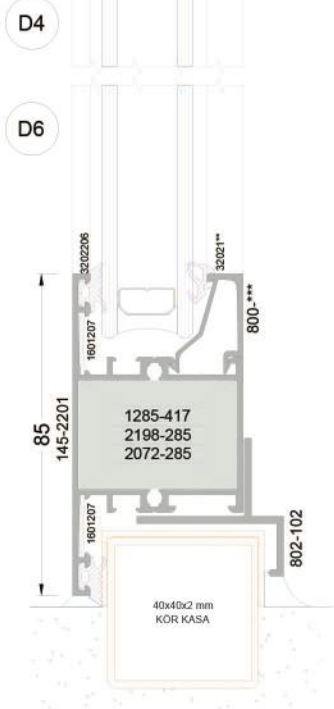
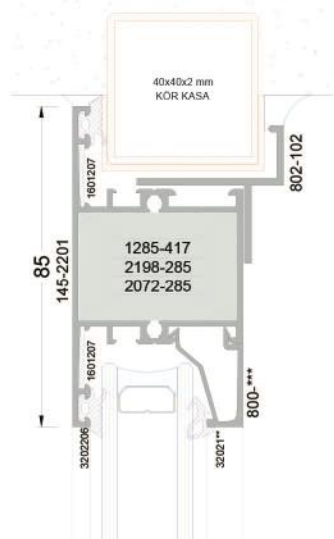
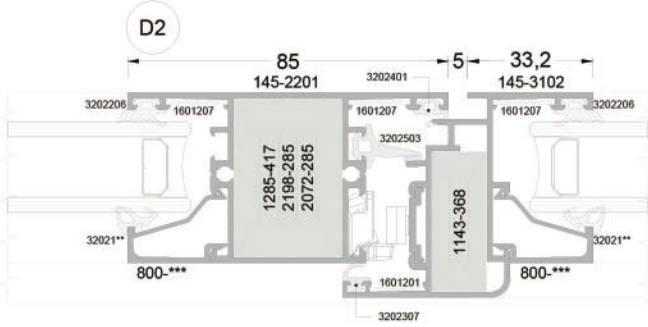
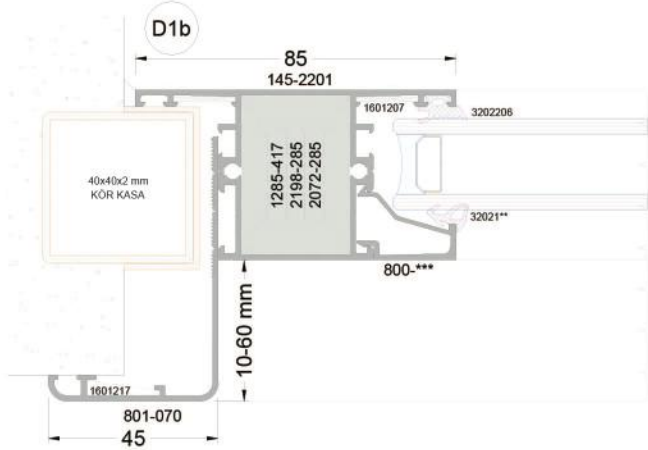
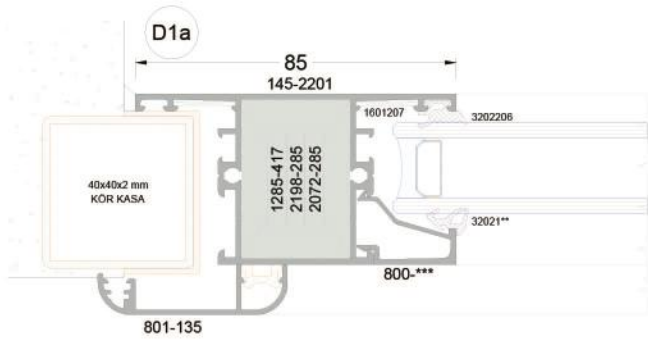
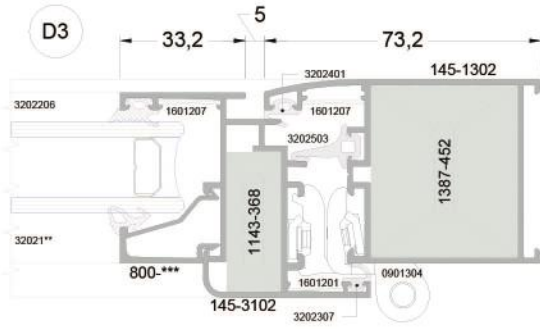
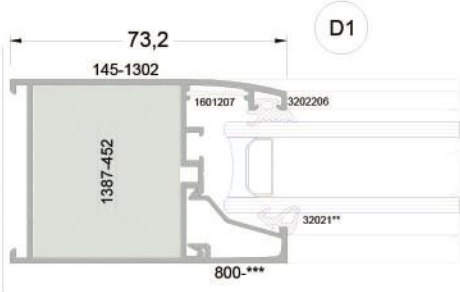
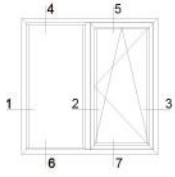

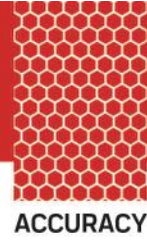

ACCURACY

HARMONY

BALANCE

