

WAT 55

YALITIMLI KAPI & PENCERE
SİSTEMİ

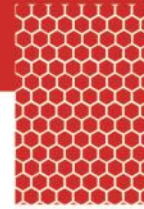

ACCURACY



HARMONY



BALANCE

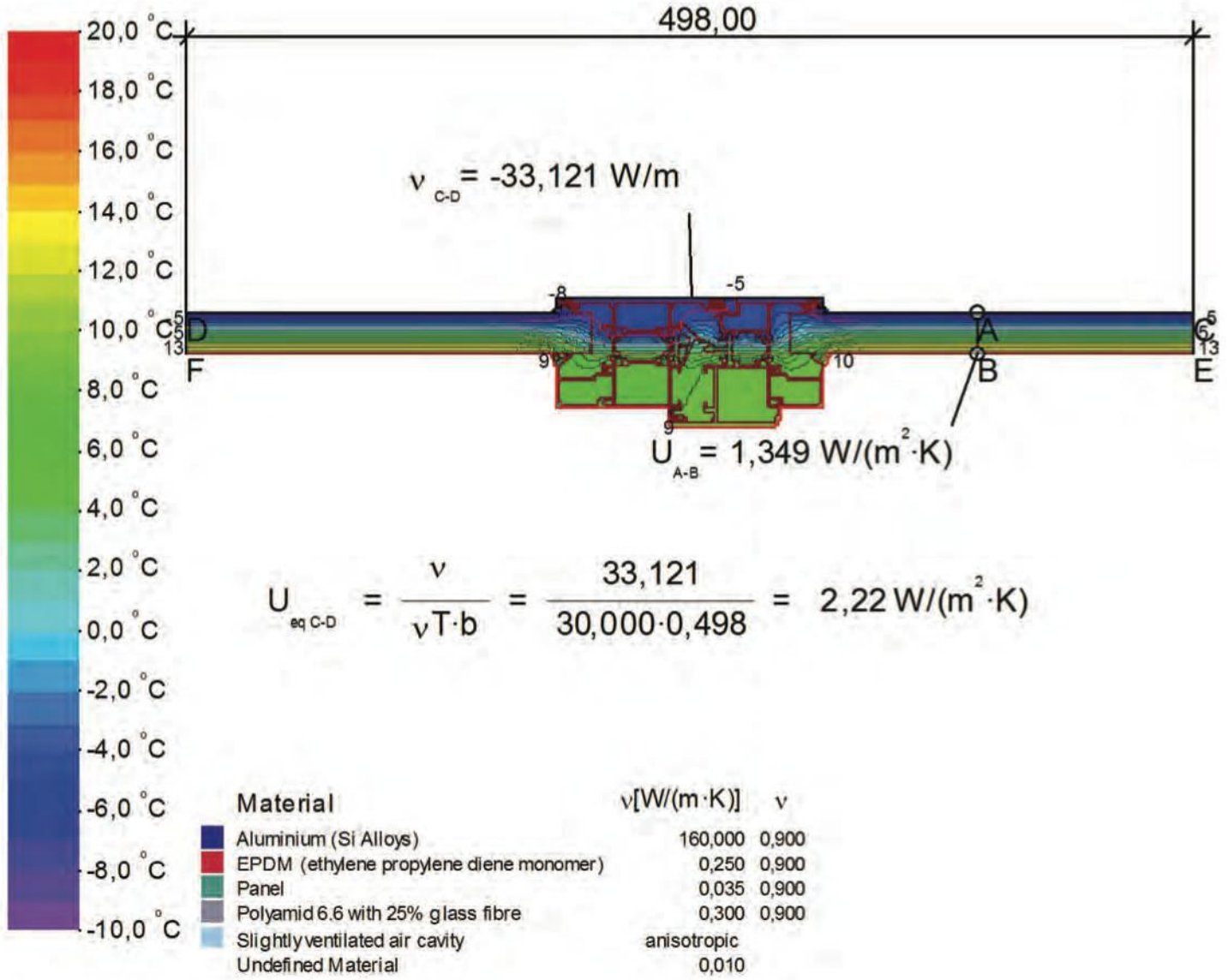

Boundary Condition	$q[\text{W/m}^2]$	$T[^\circ\text{C}]$	$R[(\text{m}^2 \cdot \text{K})/\text{W}]$	ν
Epsilon 0.9				0,900
Exterior, normal		-10,000	0,040	
Interior, normal, horizontal		20,000	0,130	
Symmetry/Model section	0,000			

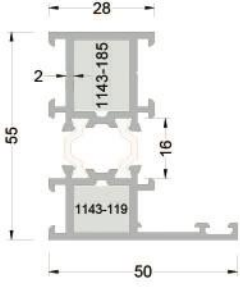

255-1101 (1,372 kg/mt.)
T55F01 DAR KASA PROFİLİ

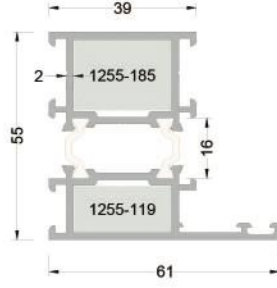

255-1201 (1,583 kg/mt.)
T55F02 GENİŞ KASA PROFİLİ

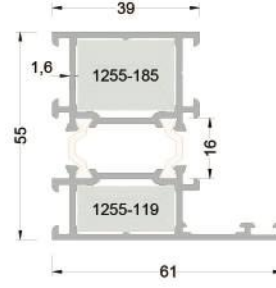

255-1202 (1,388 kg/mt.)
T55F12 GENİŞ KASA PROFİLİ

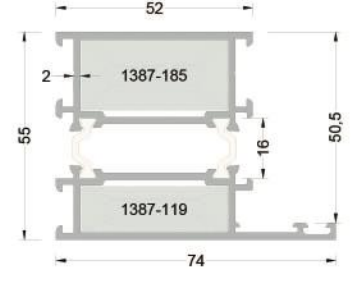

255-1301 (1,836 kg/mt.)
T55F03 BAZA KASA PROFİLİ

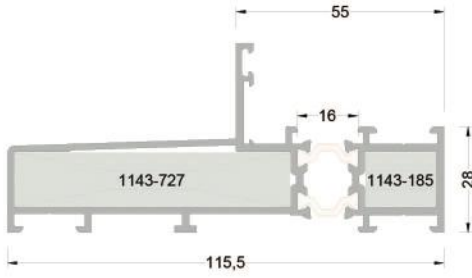

320-1404 (1,926 kg/mt.)
ST120F09 SABİT GEÇİŞ KASA PROFİLİ

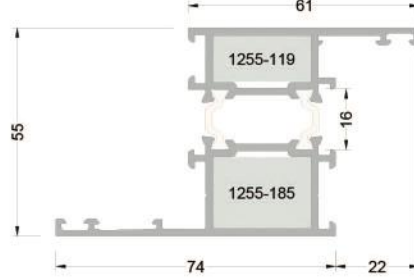

255-1501* (1,776 kg/mt.)
T55F07 PERVAZLI KASA PROFİLİ

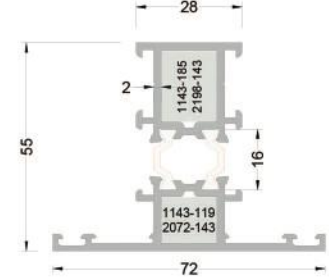

255-2101 (1,505 kg/mt.)
T55M01 DAR ORTA KAYIT PROFİLİ

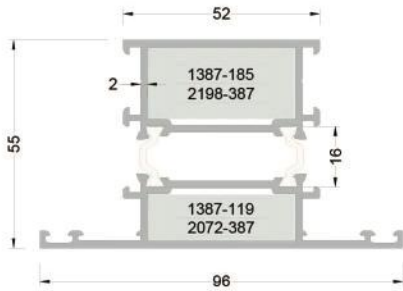

255-2301 (1,948 kg/mt.)
T55M05 GENİŞ ORTA KAYIT PROFİLİ

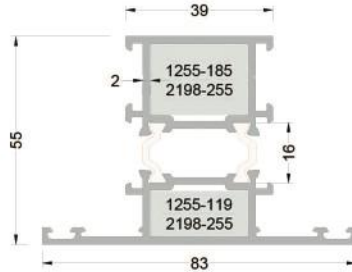

255-2201 (1,716 kg/mt.)
T55M03 ORTA KAYIT PROFİLİ

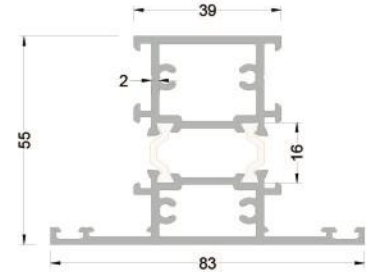

255-2202 (1,885 kg/mt.)
T55M04 ORTA KAYIT PROFİLİ VİDALI

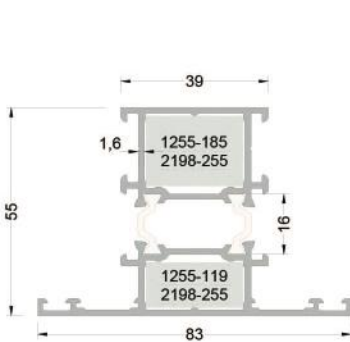

255-2203 (1,506 kg/mt.)
T55M13 ORTA KAYIT PROFİLİ

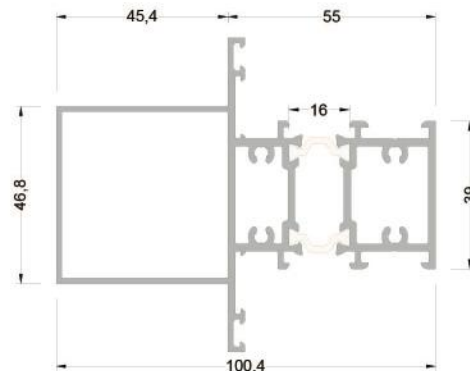

255-2502 (2,397 kg/mt.)
T55M07 TAKVİYELİ ORTA KAYIT PROFİLİ

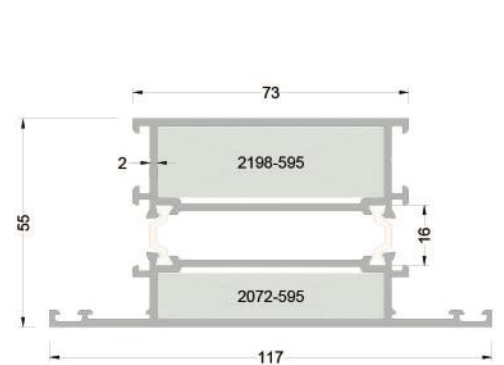

255-2401 (2,422 kg/mt.)
T55M06 BAZA ORTA KAYIT PROFİLİ

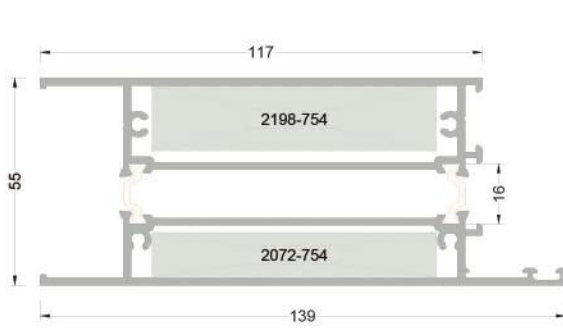
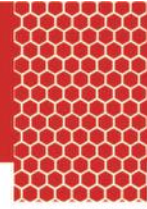

255-4401 (3,119 kg/mt)
T55K01 ETEK PROFİLİ

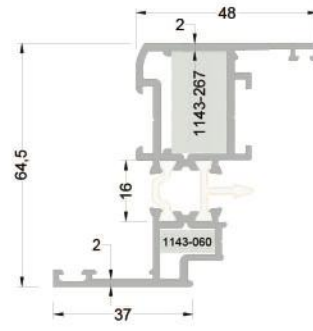

255-3102 (1,544 kg/mt)
T55V01 DAR KANAT PROFİLİ

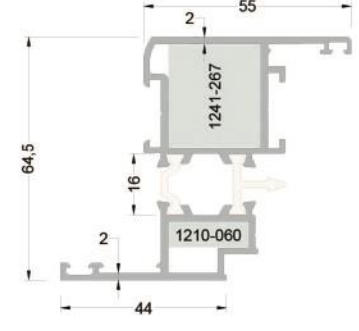

255-3204 (1,651 kg/mt)
T55V25 KANAT PROFİLİ

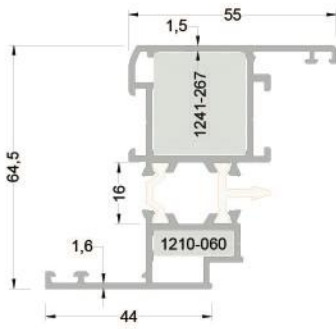

255-3205 (1,494 kg/mt)
T55V26 KANAT PROFİLİ

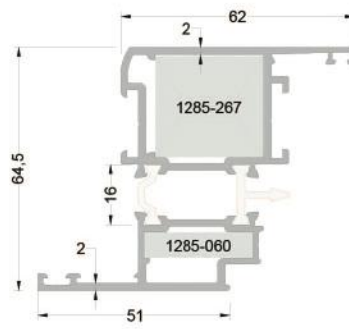

255-3201 (1,855 kg/mt)
T55V03 KANAT PROFİLİ

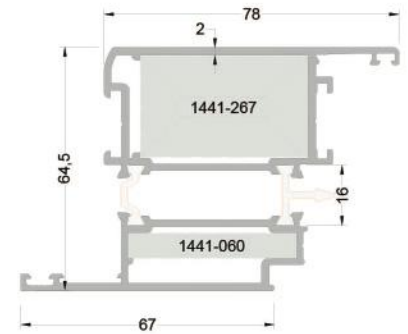

255-3401 (2,190 kg/mt)
T55V09 KAPI KANAT PROFİLİ

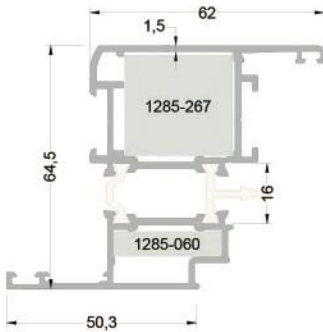

255-3203 (1,682 kg/mt)
T55V13 KANAT PROFİLİ

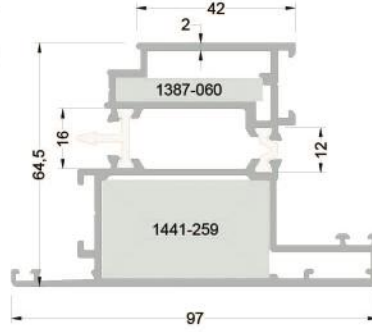

255-3403 (2,329 kg/mt)
T55V11 DIŞ AÇILIM KAPI KANAT PR.

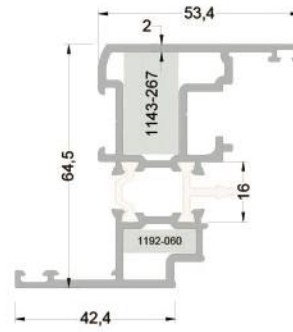

255-3604 (1,750 kg/mt)
T55V17 PVC KANAT PR.

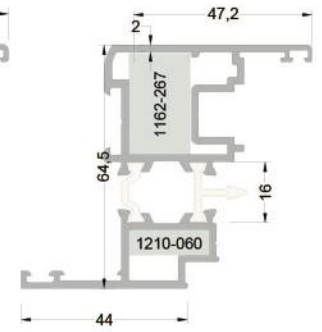

255-3608 (1,736 kg/mt)
T55V27 PVC KANAT PR.

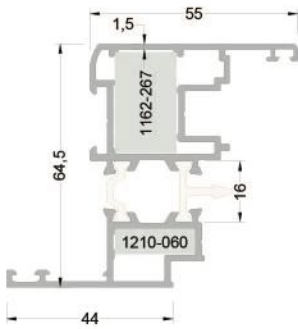

255-3609 (1,552 kg/mt)
T55V28 PVC KANAT PROFİLİ

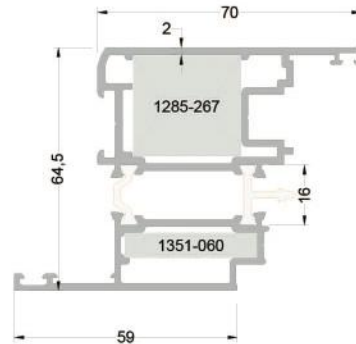

255-3601 (2,188 kg/mt)
T55V05 PVC KANAT PROFİLİ

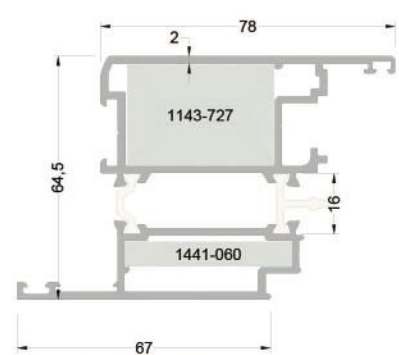

255-3610 (2,220 kg/mt)
T55V29 PVC KAPI KANAT PROFİLİ

WAT 55

YALITIMLI KAPI & PENCERE SİSTEMİ

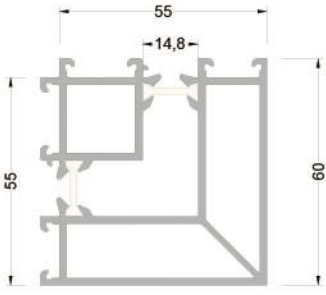

T55A08* (1,492 kg/mt)
90° DÖNÜŞ ADAPTÖR PR.

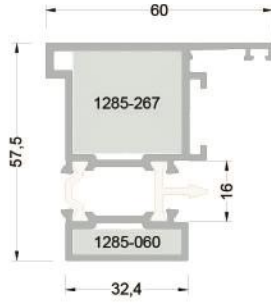

255-5104 (1,492kg/mt)
T55A04 PİVOT ADAPTÖR PR.

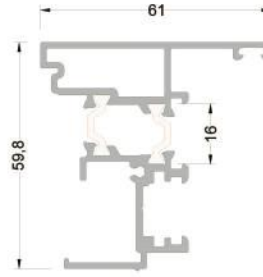

255-5101 (1,358 kg/mt)
T55A01 ÇİFT KANAT ADPTR PR.

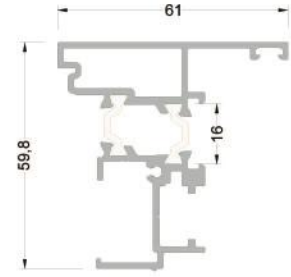

255-5102 (1,358 kg/mt)
T55A02 ÇİFT KANAT ADPTR PR.

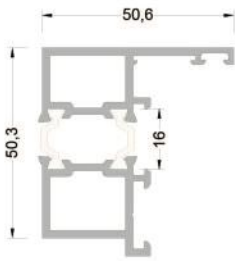

255-5103 (1,328 kg/mt)
T55A03 DIŞ AÇILIM ADPTR PR.

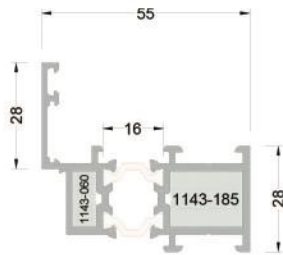

255-5105* (1,207 kg/mt)
T55A05 KANAT İÇİ KANAT ADP.



256-4101 (0,966 kg/mt)
T56K03 EŞİK PROFİLİ

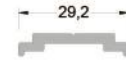

804-101 (0,110 kg/mt)
IW01 TİJ PROFİLİ

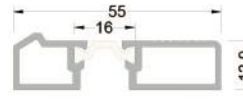

255-5205 (0,610 kg/mt)
T55 A06 EŞİK PROFİLİ



255-5204 (0,220 kg/mt)
WAT55 A05 EŞİK BİNİ PROFİLİ



255-4104 (0,304 kg/mt)
T55K06 EŞİK PROFİLİ

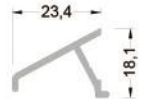

803-101 (0,186 kg/mt)
P01 DAMLALIK PROFİLİ

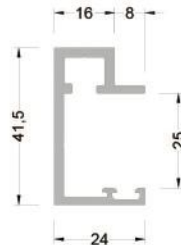

AS-8255 (0,681 kg/mt)
CAM KORKULUK DİKME PR.

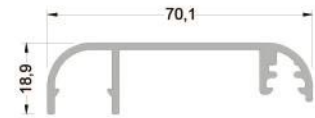

801-135 (0,357 kg/mt)
AW12 PERVAZ PROFİLİ

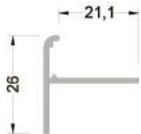

802-101 (0,185 kg/mt)
T01 T BİNİ PROFİLİ

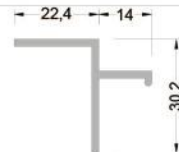

802-104 (0,126 kg/mt)
T-4680 T BİNİ PROFİLİ



801-140 (0,605 kg/mt)
AW14 PERVAZ PROFİLİ

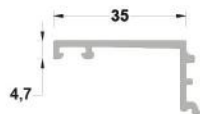

801-195 (0,293 kg/mt)
AW01 PERVAZ PROFİLİ

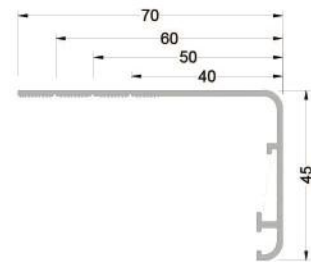

801-070 (0,525 kg/mt)
AW13 PERVAZ PROFİLİ

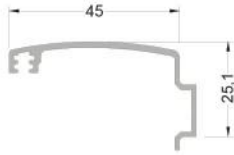

801-288 (0,377 kg/mt)
AW02 PERVAZ PROFİLİ

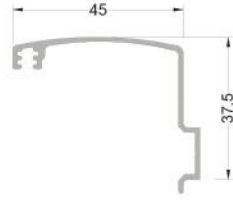

801-410 (0,343 kg/mt)
AW03 PERVAZ PROFİLİ

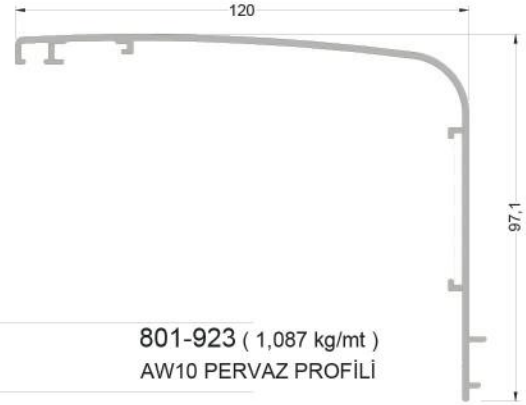

801-923 (1,087 kg/mt)
AW10 PERVAZ PROFİLİ

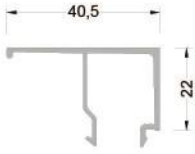

800-405 (0,345 kg/mt)
G405 CAM ÇİTASI

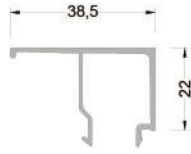

800-385 (0,332 kg/mt)
G385 CAM ÇİTASI

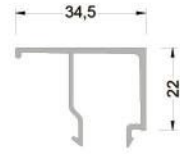

800-345 (0,320 kg/mt)
G345 CAM ÇİTASI

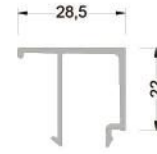

800-285 (0,300 kg/mt)
G285 CAM ÇİTASI



800-255 (0,285 kg/mt)
G255 CAM ÇİTASI

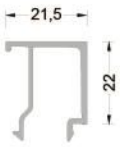

800-215 (0,273 kg/mt)
G215 CAMÇİTASI

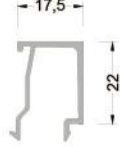

800-175 (0,258 kg/mt)
G175 CAM ÇİTASI

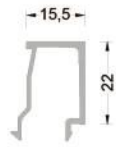

800-155 (0,249 kg/mt)
G155 CAMÇİTASI



800-120 (0,237 kg/mt)
G120 CAMÇİTASI

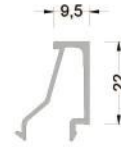

800-095 (0,232 kg/mt)
G095 CAM ÇİTASI

CAM ÇİTASI SEÇİM TABLOSU

CAM ÖLÇÜLERİ (B)	DIŞ CAM FİTLİ		İÇ CAM FİTLERİ				CAM ÇİTASI (A)
	3202206 3 mm	3202113 2-3 mm	3202114 4-5 mm	3202115 6-7 mm	3202116 8-9 mm		
4 mm	●		●			800-405	
5 mm	●	●				800-405	
6 mm	●		●			800-385	
8 mm	●	●				800-385	
10 mm	●		●			800-345	
12 mm	●	●				800-345	
16 mm	●		●			800-285	
18 mm	●	●				800-285	
20 mm	●		●			800-255	
22 mm	●		●			800-235	
24 mm	●	●				800-215	
26 mm	●			●		800-175	
28 mm	●		●			800-175	
30 mm	●	●				800-155	
32 mm	●			●		800-120	
34 mm	●		●			800-120	
36 mm	●		●			800-095	

ORTA KAYIT BAĞLANTI PROFİLLERİ İÇİN KESİM ÖLÇÜLERİ

PROFİL KODU	PARÇA KODU	KESİM ÖLÇÜSÜ	ORTA KAYIT BAĞLANTI
255-2101	2198-143	14,3 mm	2198
	2072-143	14,3 mm	2072
255-2201 255-2203	2198-255	25,5 mm	2198
	2072-255	25,5 mm	2072
255-2301	2198-387	38,7 mm	2198
	2072-387	38,7 mm	2072
255-2401*	2198-595	59,5 mm	2198
	2072-595	59,5 mm	2072
255-4401	2198-754	75,4 mm	2198
	2072-754	75,4 mm	2072



2198 (1,170 kg/mt)
ORTA KAYIT BAĞLANTI PROFİLİ



2072 (0,610 kg/mt)
ORTA KAYIT BAĞLANTI PROFİLİ

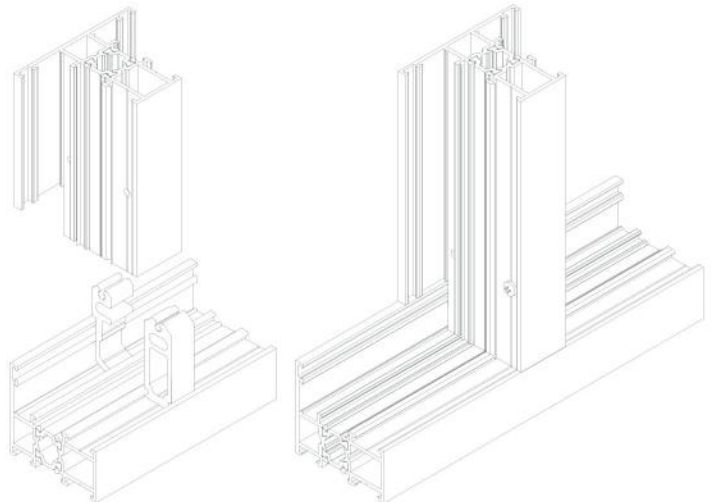

WAT 55

YALITIMLI KAPI & PENCERE SİSTEMİ



ACCURACY

HARMONY

BALANCE

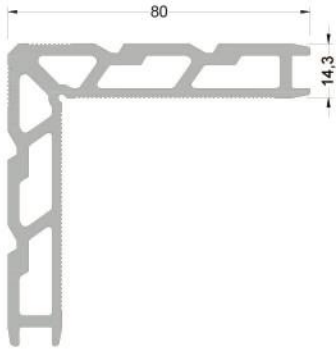

1143 (2,867 kg/mt)
L143 KÖŞE TAKOZU

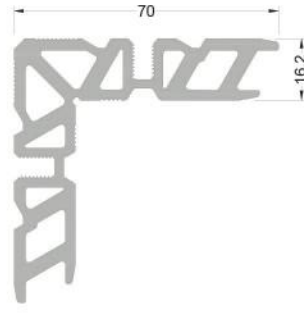

1162 (2,783 kg/mt)
L162 KÖŞE TAKOZU

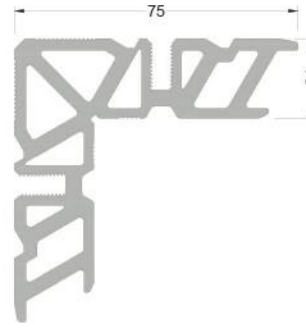

1210 (3,449 kg/mt)
L210 KÖŞE TAKOZU

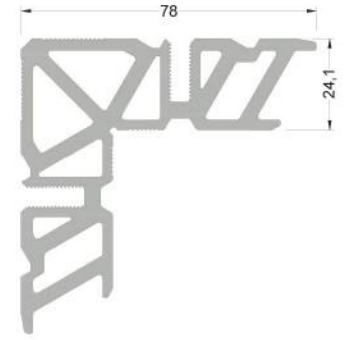

1241 (3,799 kg/mt)
L241 KÖŞE TAKOZU

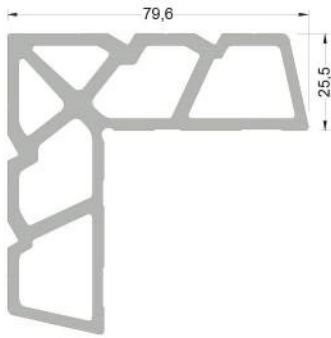

1255 (3,490 kg/mt)
L255 KÖŞE TAKOZU

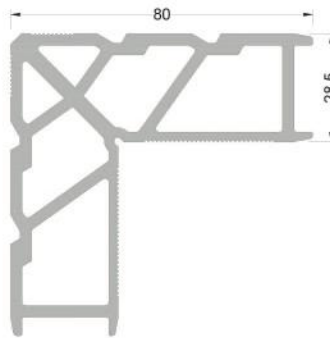

1285 (3,511 kg/mt)
L285 KÖŞE TAKOZU

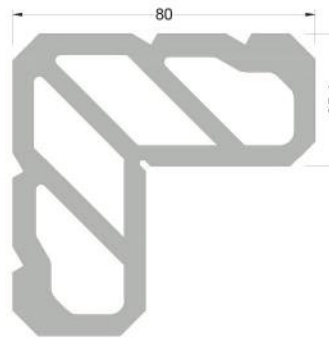

1351 (6,000 kg/mt)
L351 KÖŞE TAKOZU

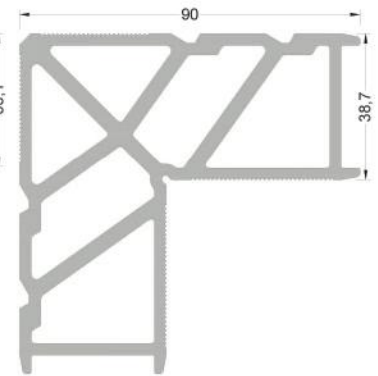

1387 (4,924 kg/mt)
L387 KÖŞE TAKOZU

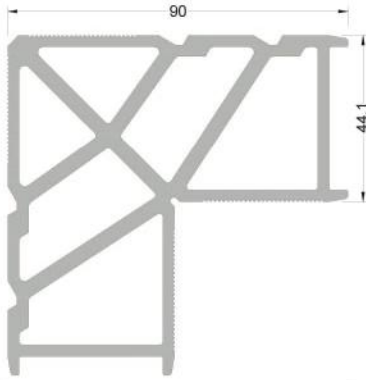

1441 (5,116 kg/mt)
L441 KÖŞE TAKOZU

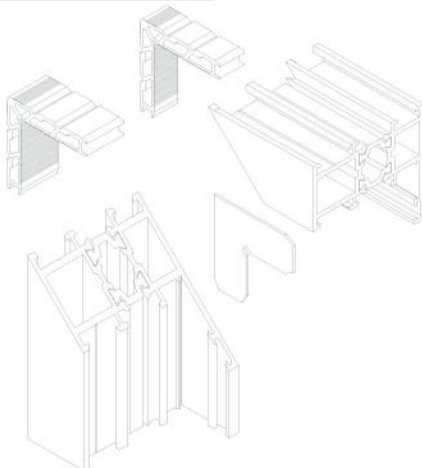

PROFİL KODU	PARÇA KODU	KESİM ÖLÇÜSÜ	KÖŞE TAKOZU
255-1101 255-2101	1143-185	18,5 mm	1143
	1143-119	11,9 mm	
255-1201 / 255-1202 255-2201 / 255-2301	1255-185	18,5 mm	1255
	1255-119	11,9 mm	
255-1301 255-2301	1387-185	18,5 mm	1387
	1387-119	11,9 mm	
320-1404	1143-727	72,7 mm	1143
	1143-185	18,5 mm	
255-1501*	1255-185	18,5 mm	1255
	1255-119	11,9 mm	
255-3102	1143-267	26,7 mm	1143
	1143-060	6,0 mm	
255-3204 255-3205	1241-267	26,7 mm	1241
	1210-060	6,0 mm	
255-3201 255-3203	1285-267	26,7 mm	1285
	1285-060	6,0 mm	
255-3401	1441-267	26,7 mm	1441
	1441-060	6,0 mm	
255-3403	1441-259	25,9 mm	1441 1387
	1387-060	6,0 mm	
255-3604	1143-267	26,7 mm	1143 1192
	1192-060	6,0 mm	
255-3608 255-3609	1162-267	26,7 mm	1162 1210
	1210-060	6,0 mm	
255-3601	1285-267	26,7 mm	1285 1351
	1351-060	6,0 mm	
255-3610	1387-267	26,7 mm	1285 1351
	1441-060	6,0 mm	
255-5104	1285-267	26,7 mm	1285
	1285-060	6,0 mm	
255-5105	1143-185	18,5 mm	1143
	1143-060	6,0 mm	

WAT 55

YALITIMLI KAPI & PENCERE SİSTEMİ

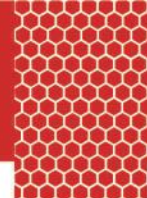

ACCURACY

HARMONY

BALANCE

ÜRÜN ÇİZİMİ	ÜRÜN KODU	ÜRÜN ADI
	3202206	DIŞ CAM FİTİLİ 3,0 mm
	3202113	FİTİL DOĞRAMA İÇ CAM 2-3 MM
	3202114	FİTİL DOĞRAMA İÇ CAM 4-5 MM
	3202115	FİTİL DOĞRAMA İÇ CAM 6-7 MM
	3202116	FİTİL DOĞRAMA İÇ CAM 8-9 MM
	3202401	FİTİL DOĞRAMA KASA 03F-01
	3202307	FİTİL DOĞRAMA KANAT 03F-09
	3202511	TOZLUK FİTİLİ WAT55
	3202314	KATLANIR KAPI KANAT DERZ FİTİLİ
	5303208	PVC CAM TAKOZU
	4801390	FİRÇA ALÜMİNYUM 90 CM
	0901204	SİSTEM MENTEŞE İKİLİ WA-01/A - 10-120
	0901302	SİSTEM MENTEŞE ÜÇLÜ WA-01/B 10-121
	0901205	SİSTEM MENTEŞE İKİLİ WA-02/A 10-122
	0901303	SİSTEM MENTEŞE ÜÇLÜ WA-02/B 10-123
	0901304	SİSTEM PENCERE / KAPI MENTEŞE 90 Kg
	0901207	SİSTEM AĞIR YÜK KAPI MENTEŞE İTHAL 160 Kg
	0901206	SİSTEM KAPI MENTEŞE İTHAL 100 Kg
	0901208	SİSTEM AĞIR YÜK KAPI MENTEŞESİ İKİLİ 160 Kg
	0901305	SİSTEM AĞIR YÜK KAPI MENTEŞESİ ÜÇLÜ 160 Kg
	0901910	AĞIR YÜK MENTEŞE ALT BESLEME APARATI 7 mm
	0901103	PIVOT MENTEŞE WA-03
	0501035	KALE BAREL 86 MM ASİMETRİK 26+10+50

ÜRÜN ÇİZİMİ	ÜRÜN KODU	ÜRÜN ADI
	0521203	35MM DİLLİ DAİRE KİLİT
	0521304	35MM MAKARALI KAPI KİLİT
	0501211	DİLLİ TOROS KİLİT 35*85
	0601104	KARŞILIK KİLİT SİSTEM MAKARALI
	0601006	KARŞILIK KİLİT SİSTEM DİLLİ
	0101932	KAPI KOLU İTHAL
	0101923	KAPI KOLU YERLİ
	0524601	TRANSMİSYON KUTUSU 7MM İTHAL
	0524602	TRANSMİSYON KUTUSU 33,5MM 90 DERECE
	0201017	EKSENEL PENCERE KOLU İTHAL
	0201018	KİLİTLİ EKSENEL PENCERE KOLU İTHAL
	1501929	TİJ PİMİ İZO DOĞRAMA 15-161
	0616300	AYARLANABİLİR KİLİTLEME KARŞILIĞI
	1603400	KANAT KALDIRMA KİTİ
	5016100	KANAT LİMİTÖR KISA
	5016102	KANAT LİMİTÖR UZUN
	5001119	VASİSTAS MAKAS SİSTEM 185 MM
	5001001	VASİSTAS ÇİT ÇİT AMANOS 04-112
	0524603	LEVYE KOLLU ZİT YÖNLÜ KİLİTLEME SETİ
	0701200	SÜRGÜ SİSTEM UZUN
	0701100	SÜRGÜ SİSTEM KISA
	5303005	ÇİFT KANAT ADAPTÖR KAPAĞI WAT55
	1601952	TESPİT APARATI

ÜRÜN ÇİZİMİ	ÜRÜN KODU	ÜRÜN ADI
	5303100	TAHLİYE KAPAĞI WA-15
	4801390	FİRÇA ALÜMİNYUM 90 CM
	4801300	FİRÇA ALÜMİNYUM 100 CM
	1602500	PVC EŞİK - KASA BAĞLANTI PLASTİĞİ
	1602501	CAM KORKULUK PVC KAPAK
	7803002	PLASTİK U PROFİLİ 40*15 MM YB-P01
	1601200	KÖŞE ÇAVUŞU ALT CL-01
	1601201	KÖŞE ÇAVUŞU ALT CL-02
	1601207	KÖŞE ÇAVUŞU CL-11
	1601217	KÖŞE ÇAVUŞU SQUADRA FUJI 17x4.3
	2016400	SOFT ÇİFT AÇILIM SETİ İTHAL
	2016500	SOFT ÇİFT AÇILIM ÇİFT KANAT AÇILIM SETİ İTHAL
	2016000	ÇİFT AÇILIM SETİ İTHAL
	2016200	ÇİFT AÇILIM ÇİFT KANAT SETİ İTHAL
	2701001	ÇİFT AÇILIM GRUBU GR1- KAVİN 380-680 MM
	2701002	KAVİN ÇİFT AÇILIM GURUBU GR2 640-1200 MM

PENCERE AÇILIM DETAYI

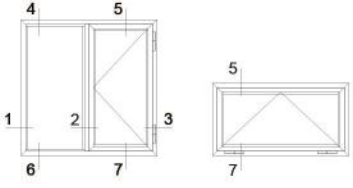

D1

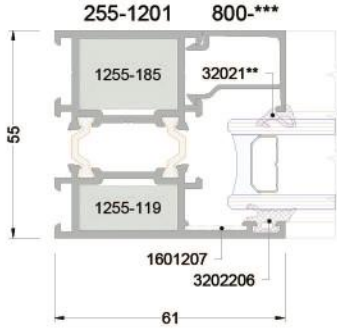

İÇ/Inside

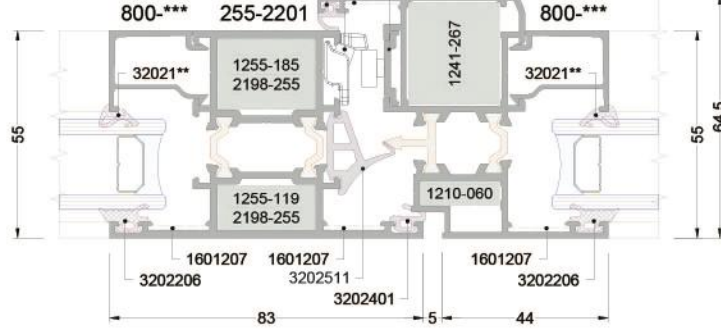

D2

D3

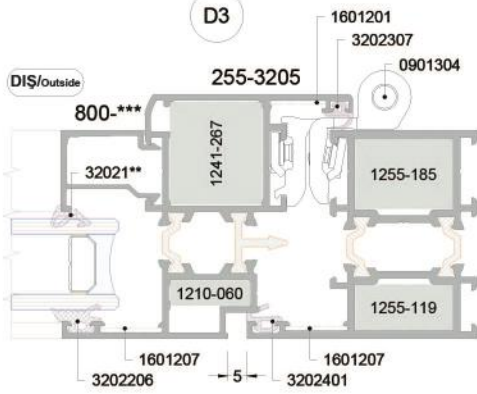

DIŞ/Outside

D5

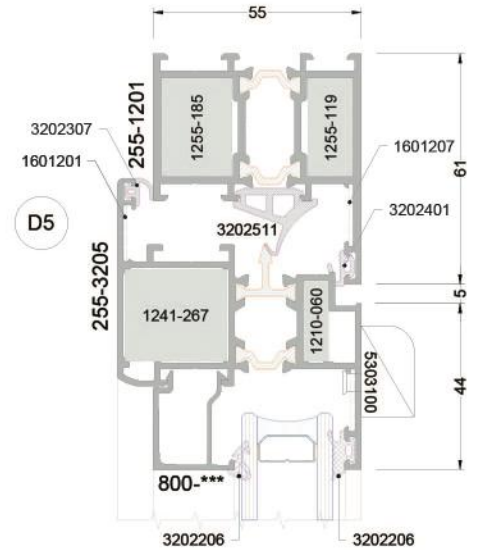

D4

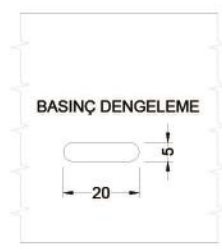
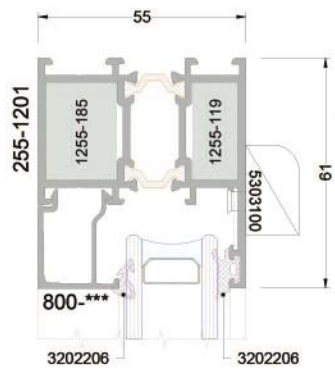

DIŞ/Outside

D6

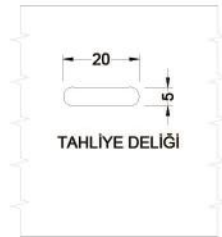
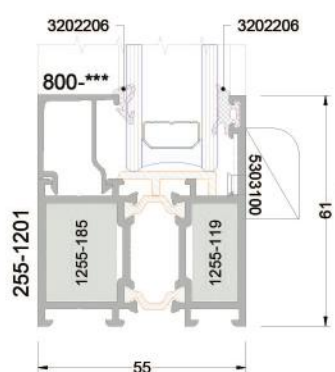

D7

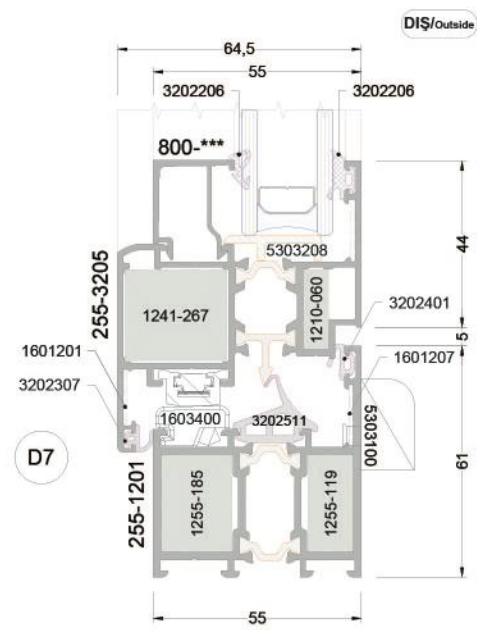

PİVOT AÇILIM UYGULAMA DETAYI

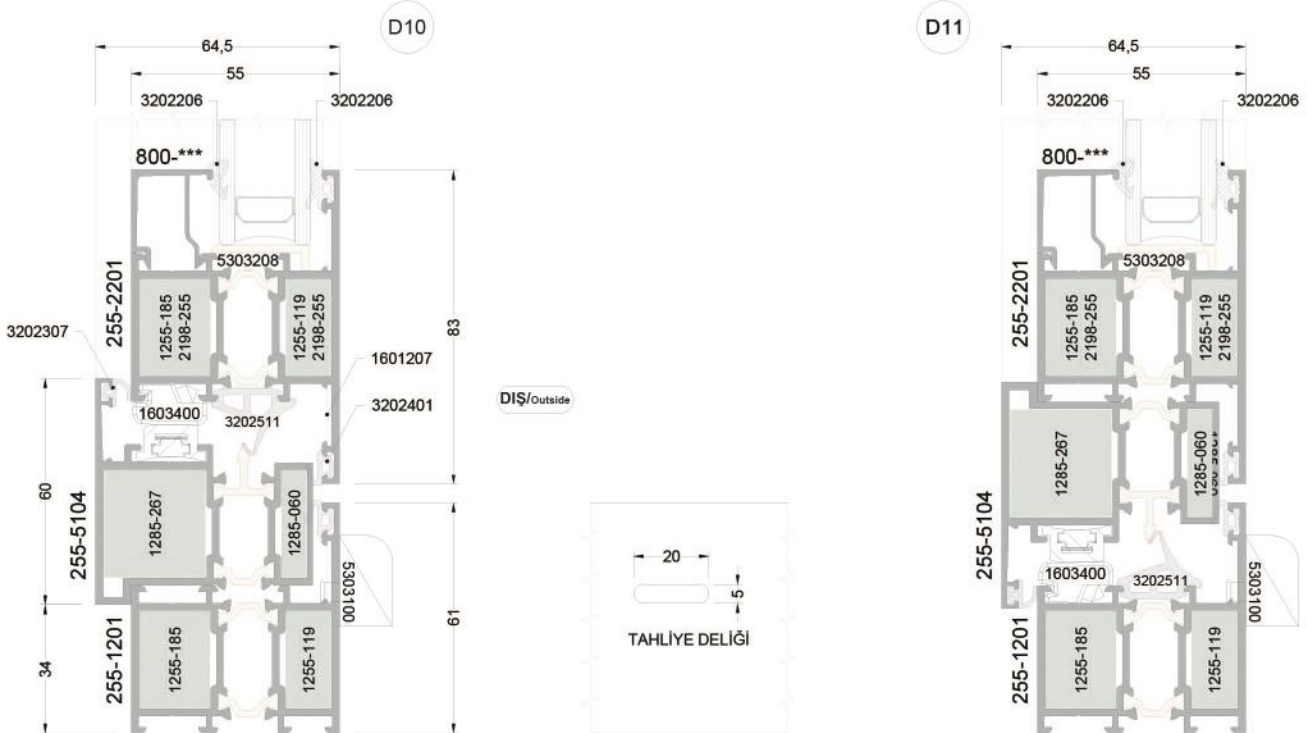
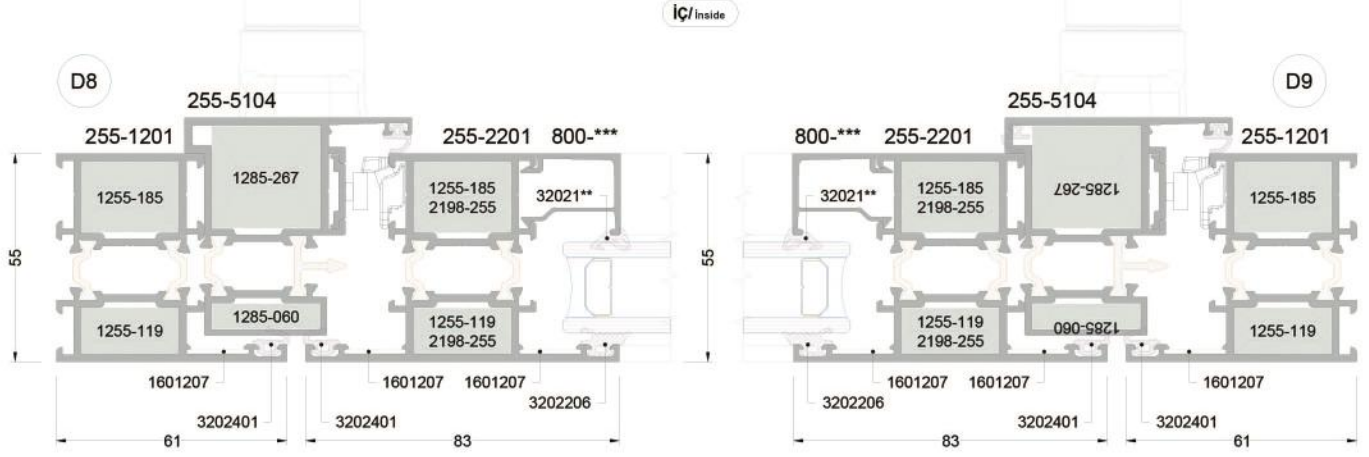
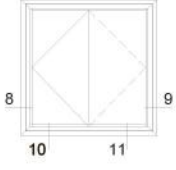

FRANSIZ BALKON CAM KÜPAŞTE UYGULAMA DETAYI

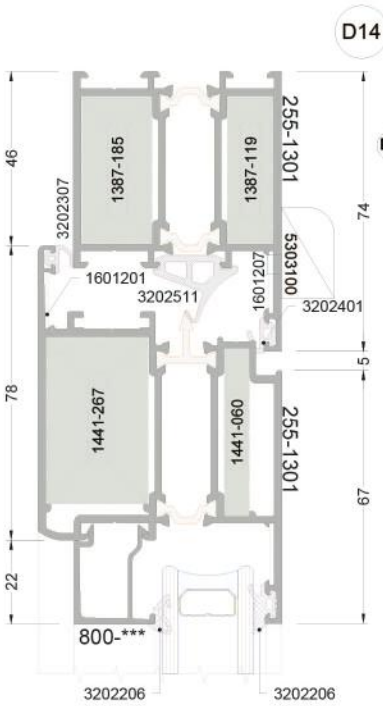
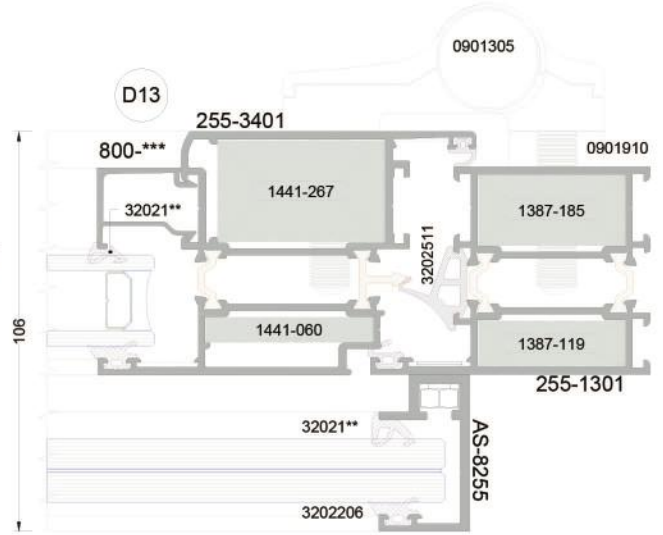
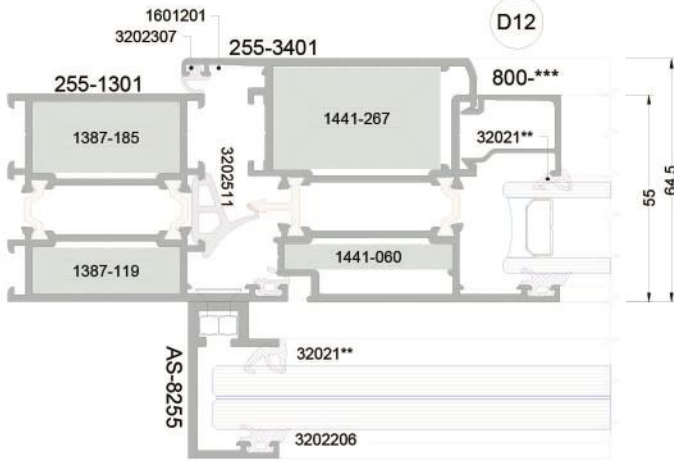
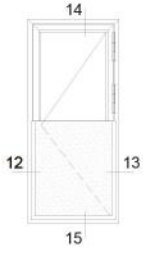

DIŞ/Outside

BASINÇ DENGELEME

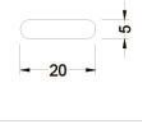

TAHLİYE DELİĞİ

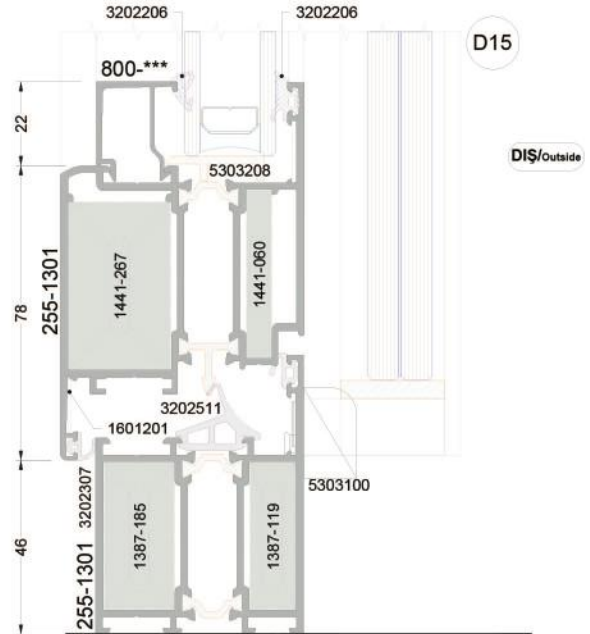
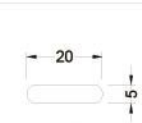

DIŞ/Outside

İÇ AÇILIM TEK KANAT KAPI DETAYI

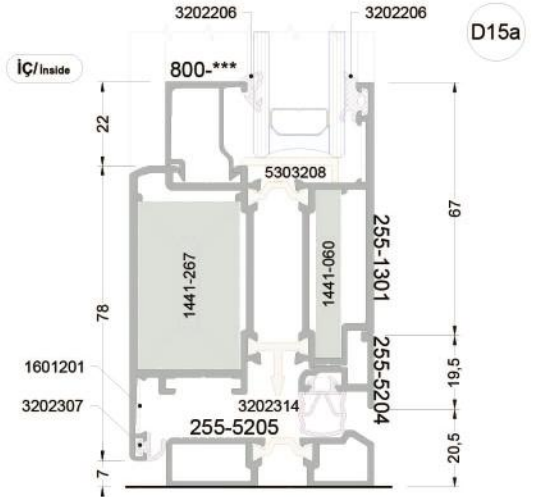
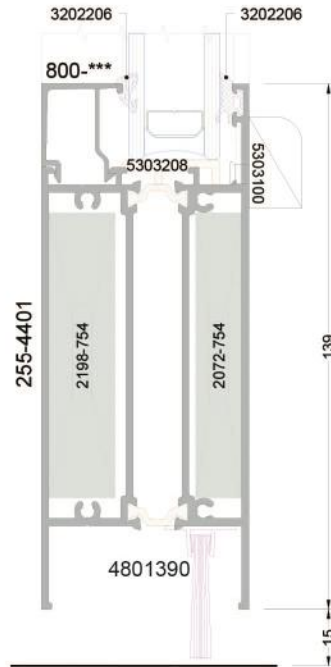
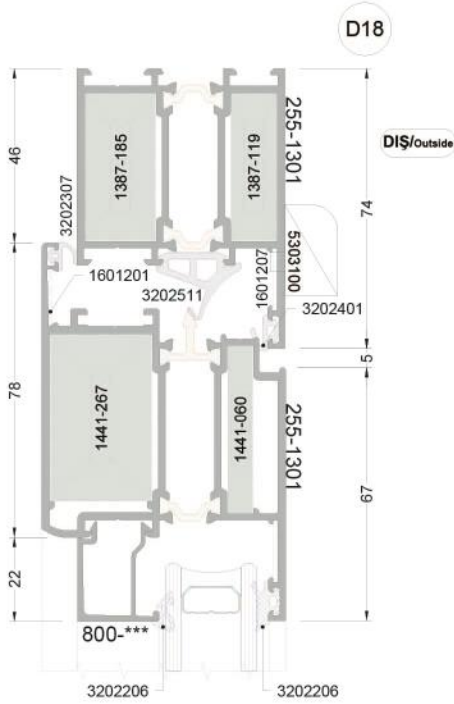
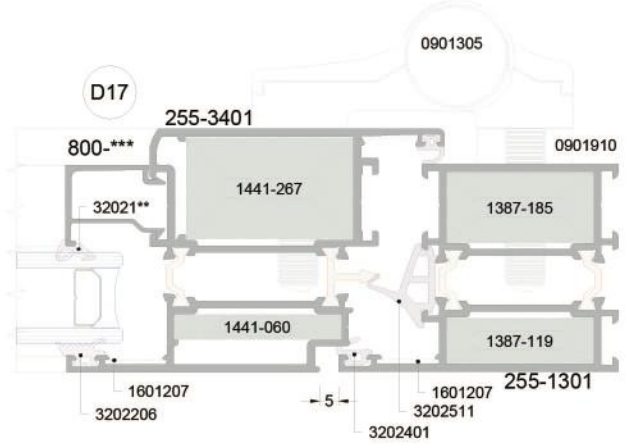
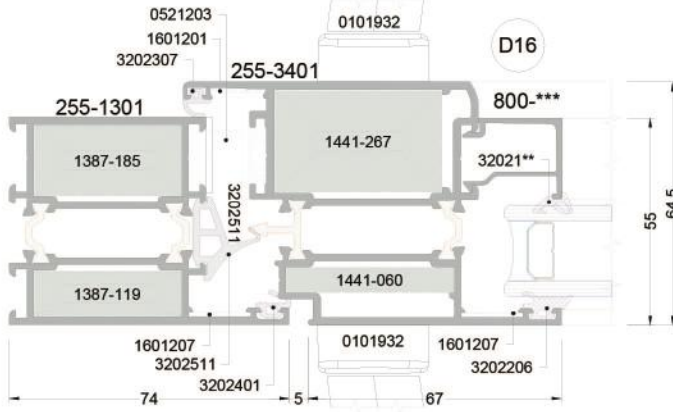
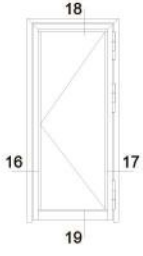

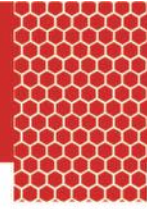

DIŞ AÇILIM ÇİFT KANAT KAPI DETAYI

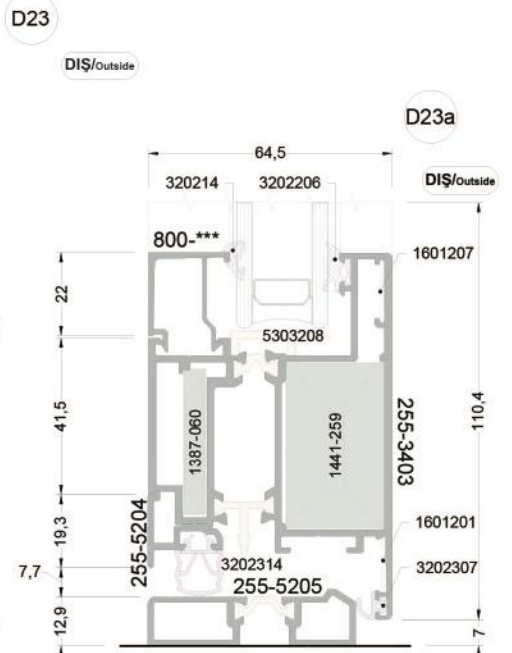
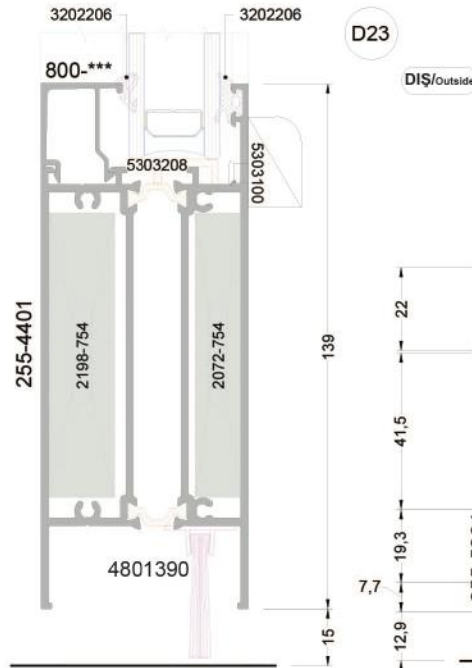
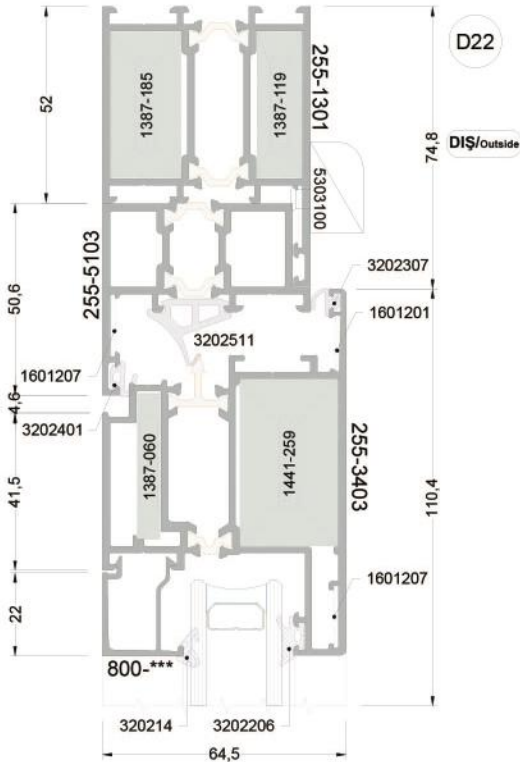
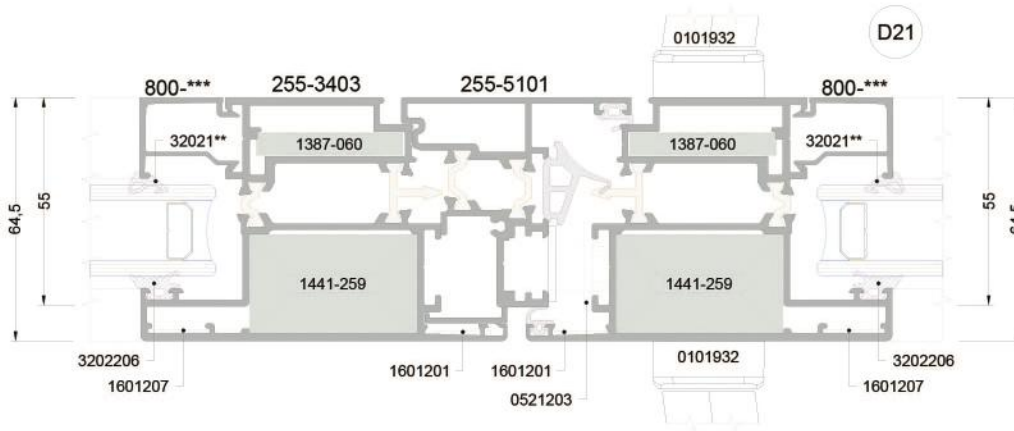
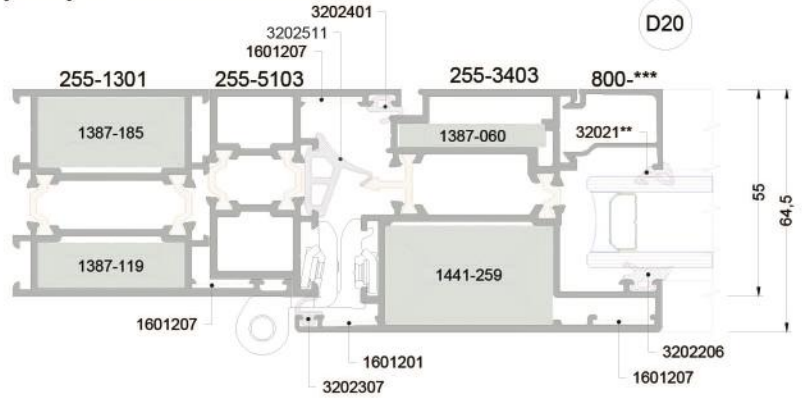

WAT 55

YALITIMLI KAPI & PENCERE SİSTEMİ

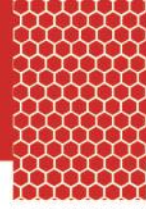

ACCURACY

HARMONY

BALANCE

