

WAT 73

YALITIMLI KAPI & PENCERE
SİSTEMİ

WAT 73

YALITIMLI KAPI & PENCERE SİSTEMİ

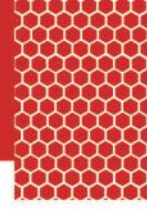

ACCURACY

HARMONY

BALANCE

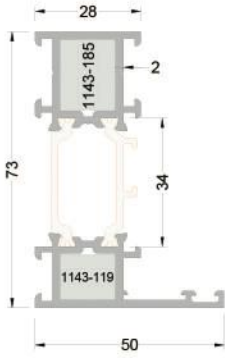

273-1101 (1,442 kg/mt)
WAT73F01 KASA PROFİLİ

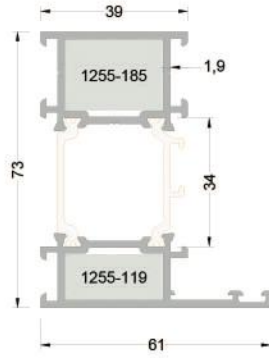

273-1201 (1,654 kg/mt)
T55F02 KASA PROFİLİ 61MM

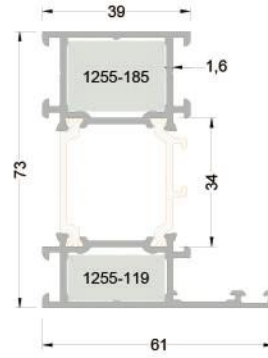

273-1202 (1,470 kg/mt)
WAT73F12 KASA PROFİLİ

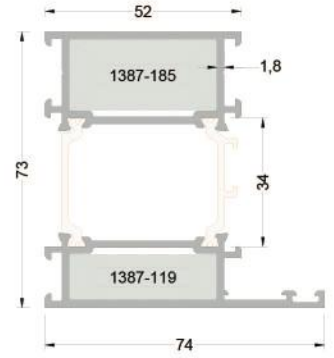

273-1301 (1,907 kg/mt)
WAT73F03 BAZA KASA PROFİLİ

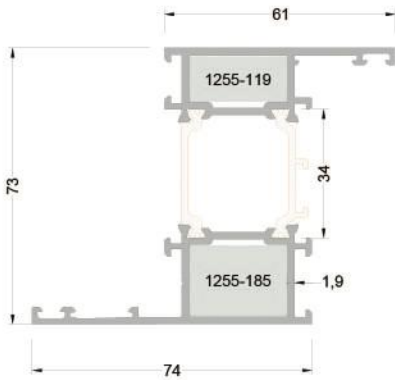

273-1501 (1,849 kg/mt)
WAT73F07 PERVAZLI KASA PROFİLİ

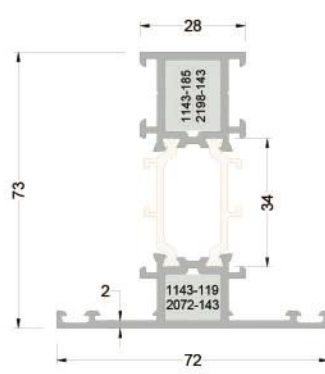

273-2101 (1,586 kg/mt)
WAT73M01 ORTA KAYIT PROFİLİ

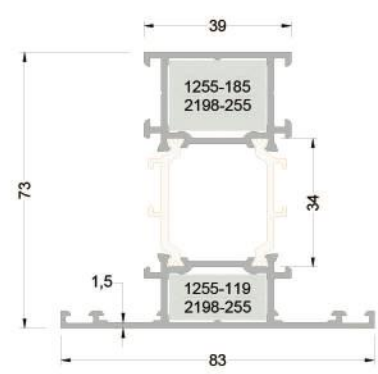

273-2203 (1,600 kg/mt)
WAT73M13 ORTA KAYIT PROFİLİ

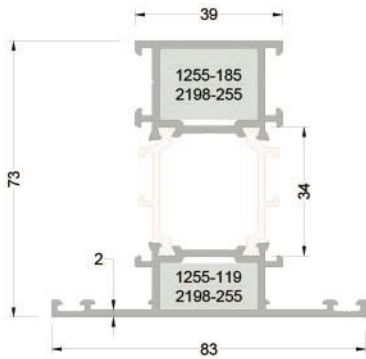

273-2201 (1,800 kg/mt)
WAT73M03 ORTA KAYIT PROFİLİ

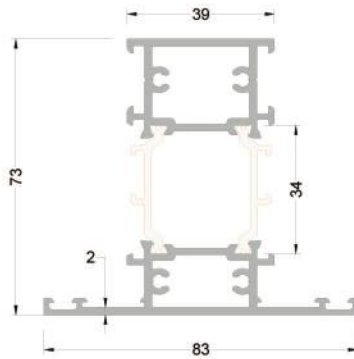

273-2202 (1,982 kg/mt)
WAT73M04 ORTA KAYIT PROFİLİ VİDALI

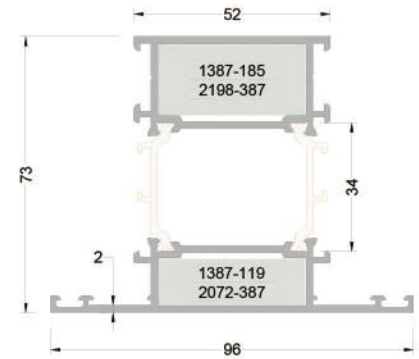

273-2301 (2,030 g/mt)
WAT73M05 ORTA KAYIT PROFİLİ

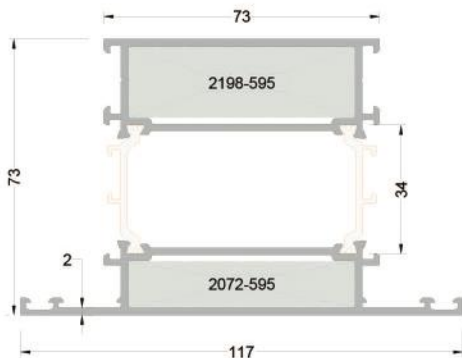

273-2401 (2,506 kg/mt)
WAT73M06 ORTA KAYIT PROFİLİ

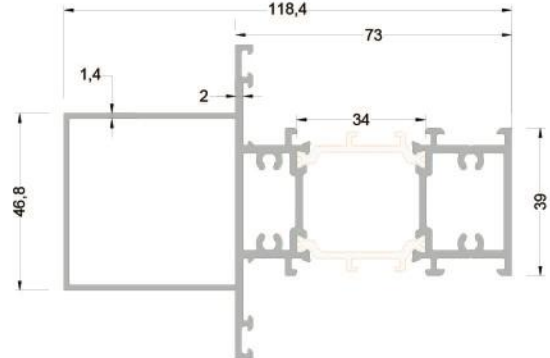

273-2502 (2,498 kg/mt)
WAT73 TAKVİYELİ ORTA KAYIT PROFİLİ

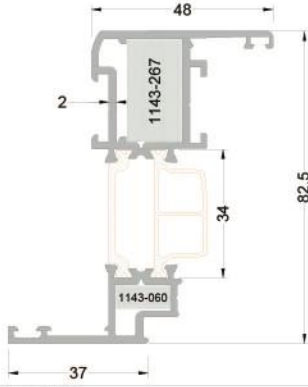

273-3102 (1,626 kg/mt)
WAT73V01 DAR KANAT PROFİLİ

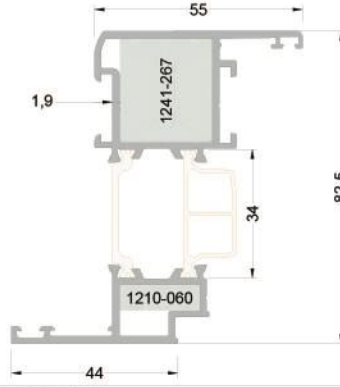

273-3204 (1,720 kg/mt)
WAT73V25 KANAT PROFİLİ

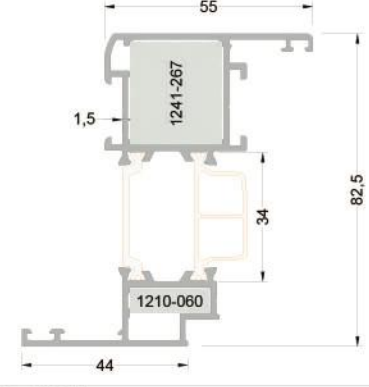

273-3205 (1,596 kg/mt)
WAT73V26 KANAT PROFİLİ

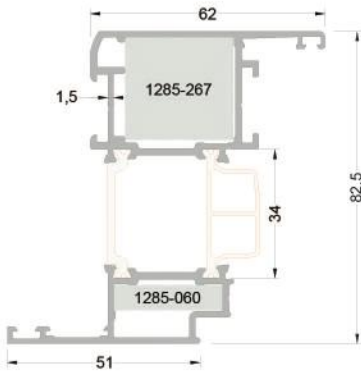

273-3201 (1,925 kg/mt)
WAT73V03 KANAT PROFİLİ

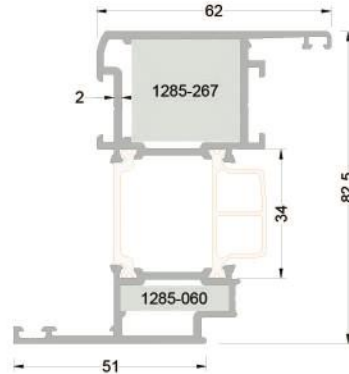

273-3203 (1,767 kg/mt)
WAT73V13 KANAT PROFİLİ

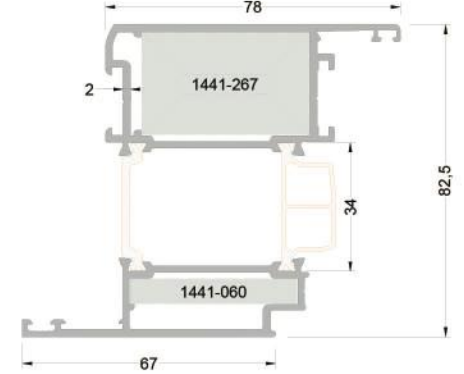

273-3401 (2,258 kg/mt)
WAT73V09 KANAT PROFİLİ 78MM

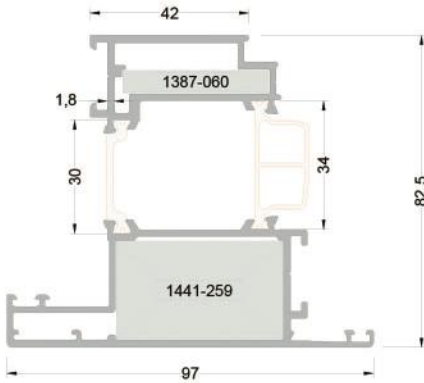

273-3403 (2,358 kg/mt)
WAT73V11 KANAT PROFİLİ DİŐA AÇILIR

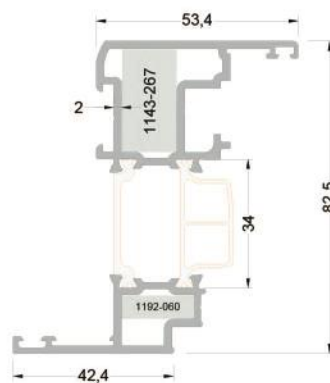

273-3604 (1,801 kg/mt)
WAT73V17 KANAT PROFİLİ 53,4MM

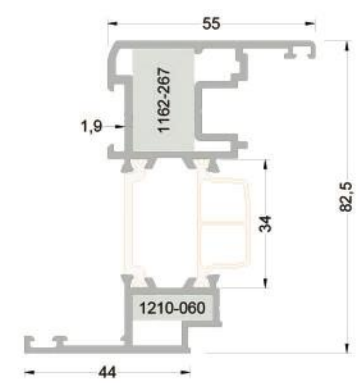

273-3608 (1,872 kg/mt)
WAT73V27 PVC KANAT PROFİLİ

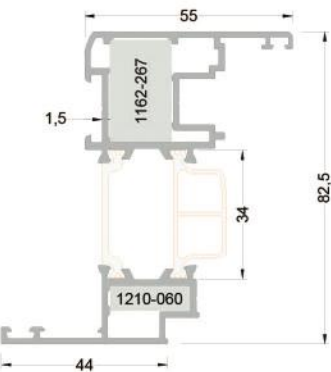

273-3609 (1,657 kg/mt)
WAT73V28 PVC KANAT PROFİLİ

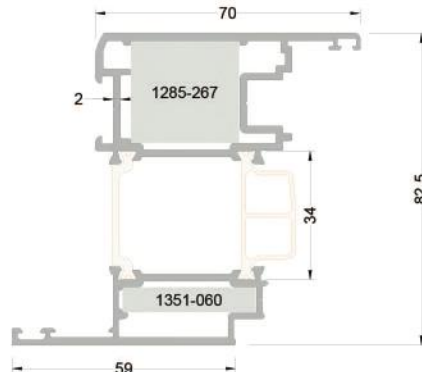

273-3601 (2,176 kg/mt)
WAT73V05 PVC KANAT PROFİLİ

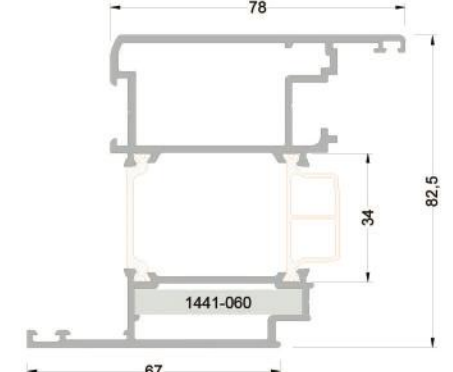

273-3610 (2,311 kg/mt)
WAT73V29 PVC KAPI KANAT PROFİLİ

WAT 73

YALITIMLI KAPI & PENCERE SİSTEMİ

ACCURACY

HARMONY

BALANCE

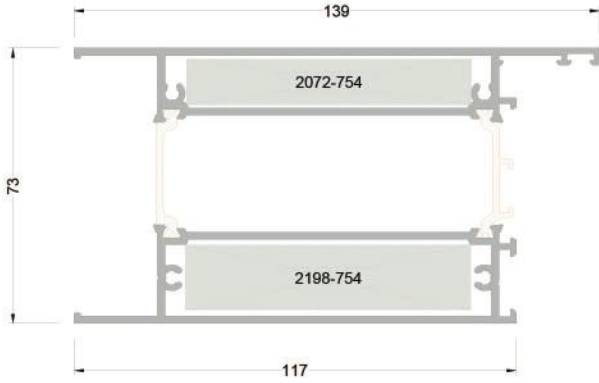

273-4401 (3,340 kg/mt)
WAT73K01 ETEK PROFİLİ

(* Sipariş öncesi kalıp bilgisi kontrol edilmeli

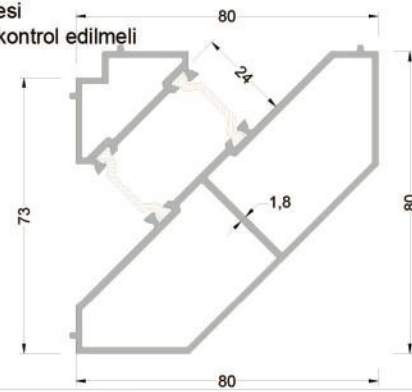

273-5106* (1,970 kg/mt)
T73A06 90° DÖNÜŞ ADAPTÖR PROFİLİ

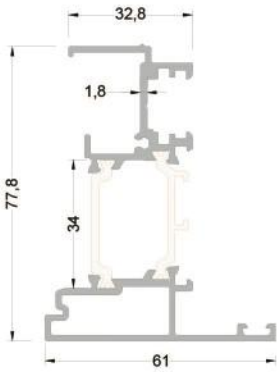

273-5101 (1,433 kg/mt)
WAT73A01 ÇİFT KANAT ADP. PR.

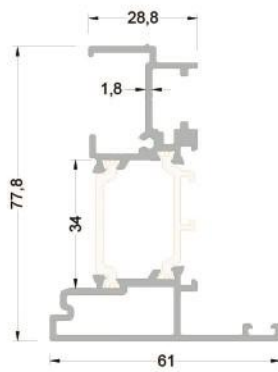

273-5102 (1,419 kg/mt)
WAT73A02 PVC KANAT ADP.PR.

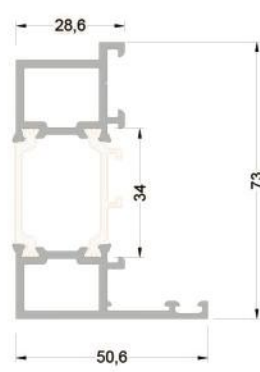

273-5103 (1,409 kg/mt)
WAT73A03 DIŞ AÇILIM ADP. PR.

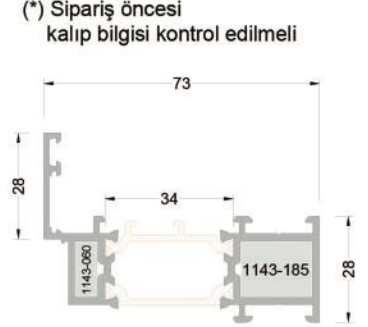

273-5105* (1,517 kg/mt)
T73A05 KANAT İÇİ KANAT ADP.



804-101 (0,110 kg/mt)
IW01 TİJ PROFİLİ

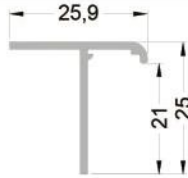

802-101 (0,185 kg/mt)
T01 T BİNİ PROFİLİ

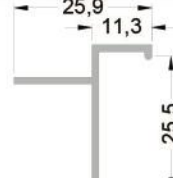

802-102 (0,188 kg/mt)
T02 T BİNİ PROFİLİ

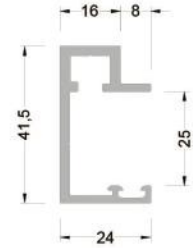

AS-8255 (0,681 kg/mt)
CAM KORKULUK DİKME PR.

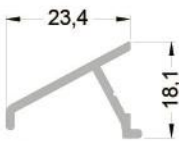

803-101 (0,186 kg/mt)
P01 DAMLALIK PROFİLİ

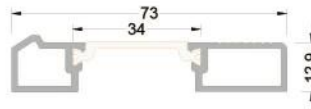

273-5205 (0,630 kg/mt)
T73 A06 EŞİK PROFİLİ

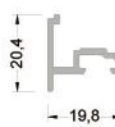

255-5204 (0,220 kg/mt)
WAT55 A05 EŞİK BİNİ PROFİLİ

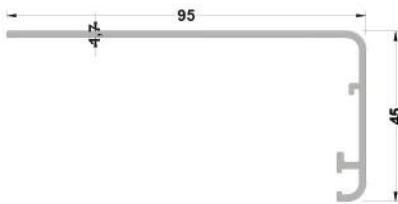

801-140 (0,605 kg/mt)
AW14 PERVAZ PROFİLİ

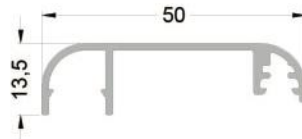

801-135 (0,357 kg/mt)
AW12 PERVAZ PROFİLİ

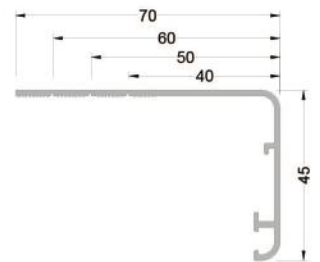

801-070 (0,525 kg/mt)
AW13 PERVAZ PROFİLİ

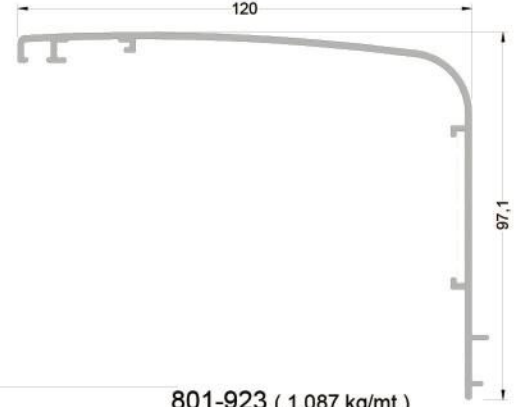
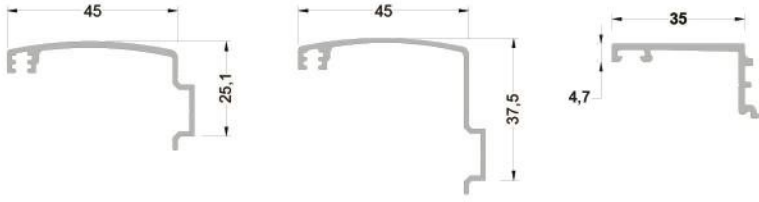

801-288 (0,377 kg/mt)
AW02 PERVAZ PROFİLİ

801-410 (0,343 kg/mt)
AW03 PERVAZ PROFİLİ

801-195 (0,293 kg/mt)
AW01 PERVAZ PROFİLİ

801-923 (1,087 kg/mt)
AW10 PERVAZ PROFİLİ



800-405 (0,340 kg/mt)
G405 CAM ÇİTASI

800-345 (0,320 kg/mt)
G345 CAM ÇİTASI

800-285 (0,300 kg/mt)
G285 CAM ÇİTASI

800-235 (0,285 kg/mt)
G235 CAM ÇİTASI

800-175 (0,260 kg/mt)
G175 CAM ÇİTASI

CAM ÇİTASI SEÇİM TABLOSU

CAM ÖLÇÜLERİ (B)	DIŞ CAM FİTİLİ		İÇ CAM FİTİLERİ			CAM ÇİTASI (A)
	3202206 3 mm	3202114 4-5 mm	3202115 6-7 mm	3202116 8-9 mm		
16 mm	●				●	800-405
18 mm	●		●			800-405
20 mm	●	●				800-405
22 mm	●				●	800-345
24 mm	●		●			800-345
26 mm	●	●				800-345
28 mm	●				●	800-285
30 mm	●		●			800-285
32 mm	●	●				800-285
34 mm	●				●	800-235
36 mm	●				●	800-235
38 mm	●	●				800-235
40 mm	●				●	800-175
42 mm	●		●			800-175
44 mm	●	●				800-175

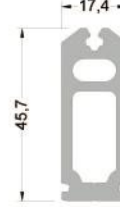

2198 (1,170 kg/mt)
ORTA KAYIT BAĞLANTI PROFİLİ



2072 (0,610 kg/mt)
ORTA KAYIT BAĞLANTI PROFİLİ

ORTA KAYIT BAĞLANTI PROFİLLERİ İÇİN KESİM ÖLÇÜLERİ

PROFİL KODU	PARÇA KODU	KESİM ÖLÇÜSÜ	ORTA KAYIT BAĞLANTI
273-2101	2198-143	14,3 mm	2198
	2072-143	14,3 mm	2072
273-2201 273-2203	2198-255	25,5 mm	2198
	2072-255	25,5 mm	2072
273-2301	2198-387	38,7 mm	2198
	2072-387	38,7 mm	2072
273-2401*	2198-595	59,5 mm	2198
	2072-595	59,5 mm	2072
273-4401	2198-754	75,4 mm	2198
	2072-754	75,4 mm	2072

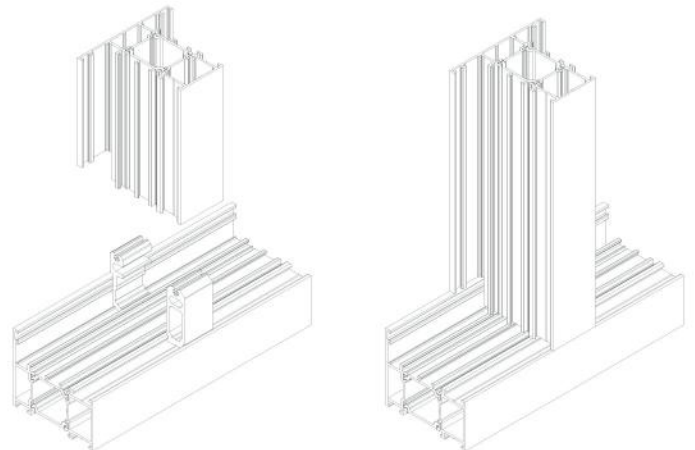

WAT 73

YALITIMLI KAPI & PENCERE SİSTEMİ



ACCURACY

HARMONY

BALANCE

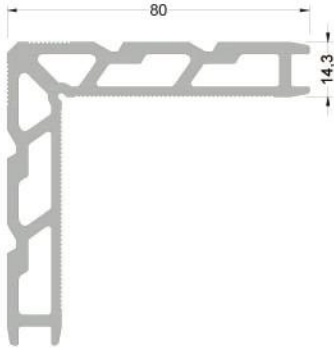

1143 (2,867 kg/mt)
L143 KÖŞE TAKOZU

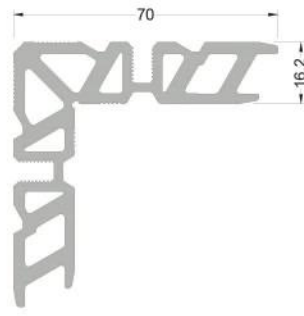

1162 (2,783 kg/mt)
L162 KÖŞE TAKOZU

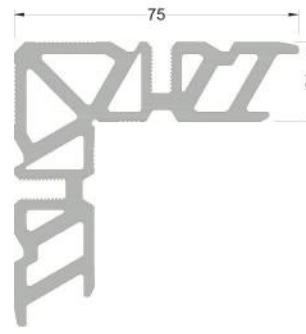

1210 (3,449 kg/mt)
L210 KÖŞE TAKOZU

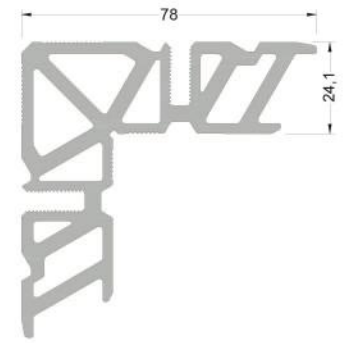

1241 (3,799 kg/mt)
L241 KÖŞE TAKOZU

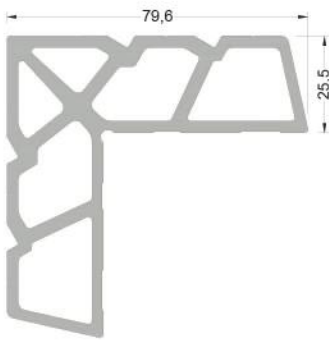

1255 (3,490 kg/mt)
L255 KÖŞE TAKOZU

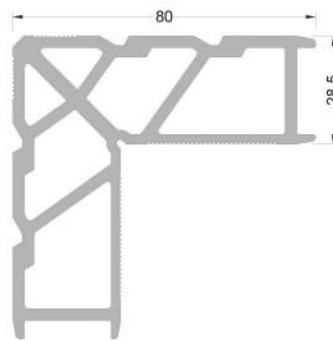

1285 (3,511 kg/mt)
L285 KÖŞE TAKOZU

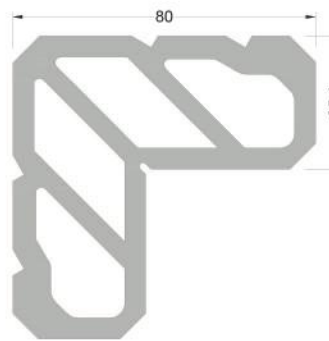

1351 (6,000 kg/mt)
L351 KÖŞE TAKOZU

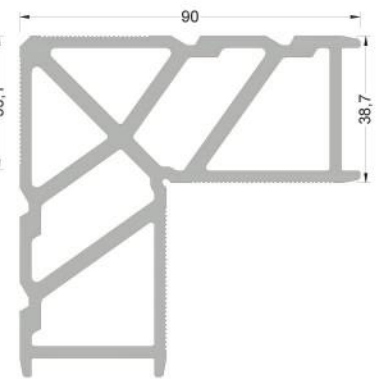

1387 (4,924 kg/mt)
L387 KÖŞE TAKOZU

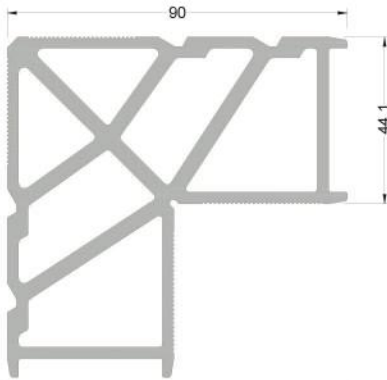

1441 (5,116 kg/mt)
L441 KÖŞE TAKOZU

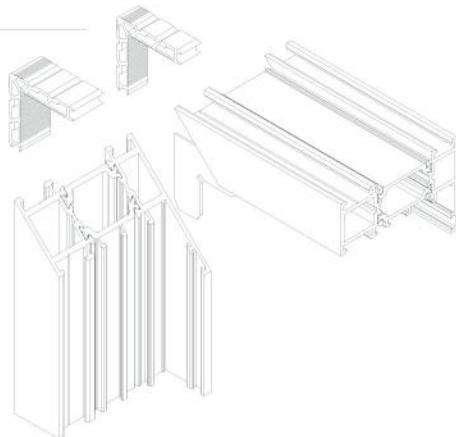

PROFİL KODU	PARÇA KODU	KESİM ÖLÇÜSÜ	KÖŞE TAKOZU
273-1101 273-2101	1143-185 1143-119	18,5 mm 11,9 mm	1143
273-1201 / 273-1202 273-2201 / 273-2301	1263-185 1263-119	18,5 mm 11,9 mm	1255
273-1301 273-2301	1387-185 1387-119	18,5 mm 11,9 mm	1387
320-1404	1143-727 1143-185	72,7 mm 18,5 mm	1143
273-1501*	1255-185 1255-119	18,5 mm 11,9 mm	1255
273-3102	1143-267 1143-060	26,7 mm 6,0 mm	1143
273-3204 273-3205	1241-267 1210-060	26,7 mm 6,0 mm	1241 1210
273-3201 273-3203	1285-267 1285-060	26,7 mm 6,0 mm	1285
273-3401	1441-267 1441-060	26,7 mm 6,0 mm	1441
273-3403	1441-259 1387-060	25,9 mm 6,0 mm	1441 1387
273-3604	1143-267 1192-060	26,7 mm 6,0 mm	1143 1192
273-3608 273-3609	1162-267 1210-060	26,7 mm 6,0 mm	1162 1210
273-3601	1285-267 1351-060	26,7 mm 6,0 mm	1285 1351
273-3610	1387-267 1441-060	26,7 mm 6,0 mm	1285 1351

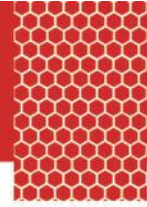

ACCURACY

HARMONY

BALANCE

ÜRÜN ÇİZİMİ	ÜRÜN KODU	ÜRÜN ADI
	3202206	DIŞ CAM FİTİLİ 3,0 mm
	3202113	FİTİL DOĞRAMA İÇ CAM 2-3 MM
	3202114	FİTİL DOĞRAMA İÇ CAM 4-5 MM
	3202115	FİTİL DOĞRAMA İÇ CAM 6-7 MM
	3202116	FİTİL DOĞRAMA İÇ CAM 8-9 MM
	3202401	FİTİL DOĞRAMA KASA 03F-01
	3202307	FİTİL DOĞRAMA KANAT 03F-09
	3222501	TOZLUK FİTİLİ
	3202314	KATLANIR KAPI KANAT DERZ FİTİLİ
	5303208	PVC CAM TAKOZU
	0901204	SİSTEM MENTEŞE İKİLİ WA-01/A - 10-120
	0901302	SİSTEM MENTEŞE ÜÇLÜ WA-01/B 10-121
	0901205	SİSTEM MENTEŞE İKİLİ WA-02/A 10-122
	0901303	SİSTEM MENTEŞE ÜÇLÜ WA-02/B 10-123
	0901304	SİSTEM PENCERE / KAPI MENTEŞE 90 Kg
	0901207	SİSTEM AĞIR YÜK KAPI MENTEŞE İTHAL 160 Kg
	0901206	SİSTEM KAPI MENTEŞE İTHAL 100 Kg
	0901208	SİSTEM AĞIR YÜK KAPI MENTEŞESİ İKİLİ 160 Kg
	0901305	SİSTEM AĞIR YÜK KAPI MENTEŞESİ ÜÇLÜ 160 Kg
	0901910	AĞIR YÜK MENTEŞE ALT BESLEME APARATI 7 mm
	0501017	BAREL 26+10+70 106 mm ASİMETRİK BAREL
	0521203	35MM DİLLİ DAİRE KİLİT
	0521304	35MM MAKARALI KAPI KİLİT

ÜRÜN ÇİZİMİ	ÜRÜN KODU	ÜRÜN ADI
	0501211	DİLLİ TOROS KİLİT 35*85
	0601104	KARŞILIK KİLİT SİSTEM MAKARALI
	0601006	KARŞILIK KİLİT SİSTEM DİLLİ
	0101932	KAPI KOLU İTHAL
	0101923	KAPI KOLU YERLİ
	0524601	TRANSMİSYON KUTUSU 7MM İTHAL
	0524602	TRANSMİSYON KUTUSU 33,5MM 90 DERECE
	0201017	EKSENEL PENCERE KOLU İTHAL
	0201018	KİLİTLİ EKSENEL PENCERE KOLU İTHAL
	1501929	TİJ PİM İZO DOĞRAMA 15-161
	0616300	AYARLANABİLİR KİLİTLEME KARŞILIĞI
	1603400	KANAT KALDIRMA KİTİ
	5016100	KANAT LİMİTÖR KISA
	5016102	KANAT LİMİTÖR UZUN
	5001119	VASİSTAS MAKAS SİSTEM 185 MM
	5001001	VASİSTAS ÇİT ÇİT AMANOS 04-112
	0524603	LEVYE KOLLU ZİT YÖNLÜ KİLİTLEME SETİ
	0701200	SÜRGÜ SİSTEM UZUN
	0701100	SÜRGÜ SİSTEM KISA
	5303007	ÇİFT KANAT ADAPTÖR KAPAĞI
	1601952	TESPİT APARATI
	5303100	TAHLİYE KAPAĞI WA-15
	4801390	FİRÇA ALÜMİNYUM 90 CM

ÜRÜN ÇİZİMİ	ÜRÜN KODU	ÜRÜN ADI
	4801300	FİRÇA ALÜMİNYUM 100 CM
	1602500	PVC EŞİK - KASA BAĞLANTI PLASTİĞİ
	1602501	CAM KORKULUK PVC KAPAK
	7803001	PVC KAPAK
	1601200	KÖŞE ÇAVUŞU ALT CL-01
	1601201	KÖŞE ÇAVUŞU ALT CL-02
	1601207	KÖŞE ÇAVUŞU CL-11
	1601217	KÖŞE ÇAVUŞU SQUADRA FUJI 17x4.3
	2016400	SOFT ÇİFT AÇILIM SETİ İTHAL
	2016500	SOFT ÇİFT AÇILIM ÇİFT KANAT AÇILIM SETİ İTHAL
	2016000	ÇİFT AÇILIM SETİ İTHAL
	2016200	ÇİFT AÇILIM ÇİFT KANAT SETİ İTHAL
	2701001	ÇİFT AÇILIM GRUBU GR1- KAVİN 380-680 MM
	2701002	KAVİN ÇİFT AÇILIM GRUBU GR2 640-1200 MM

PENCERE AÇILIM DETAYI

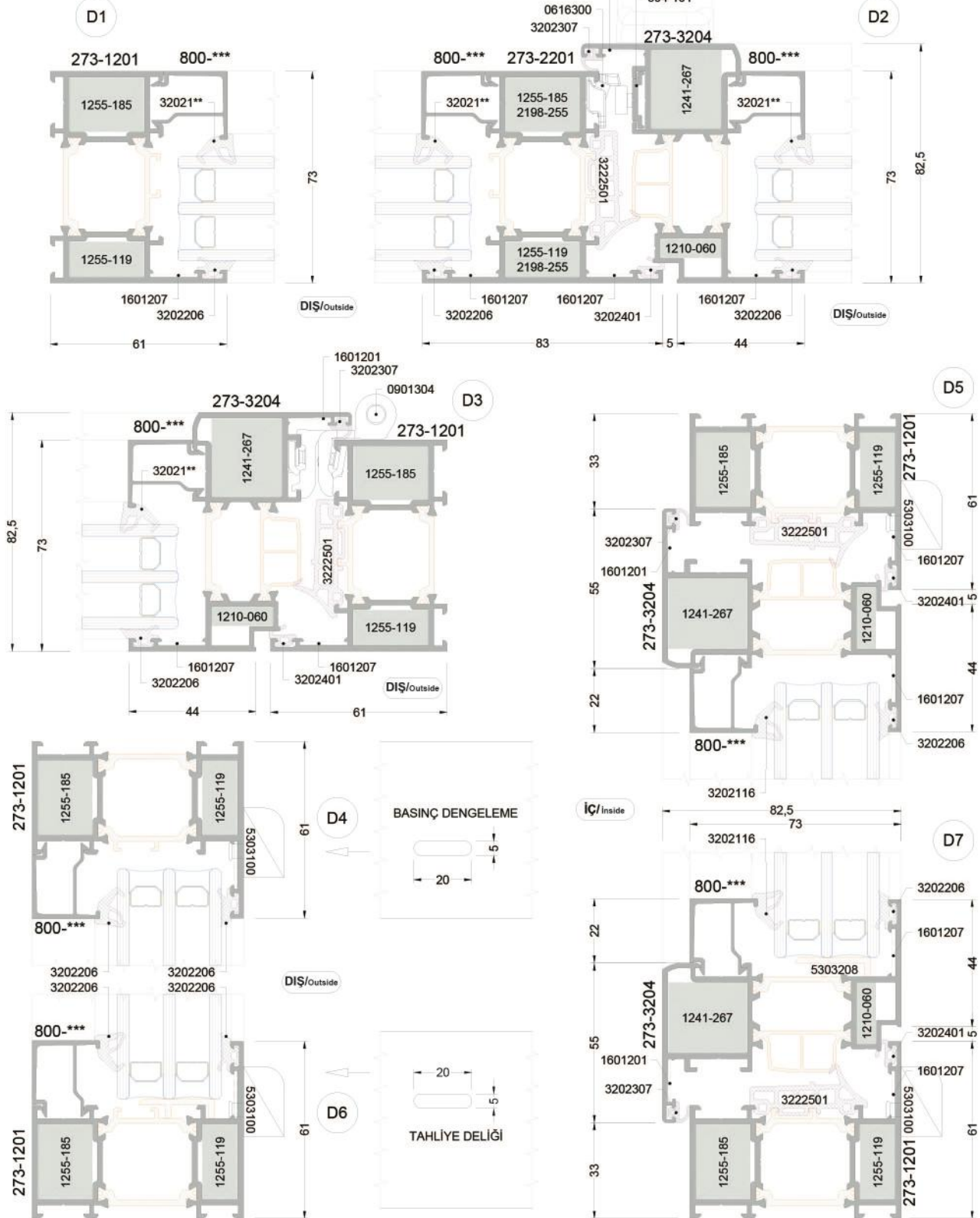
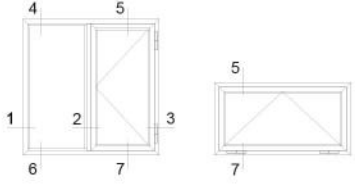

FRANSIZ BALKON CAM KÜPAŞTE UYGULAMA DETAYI

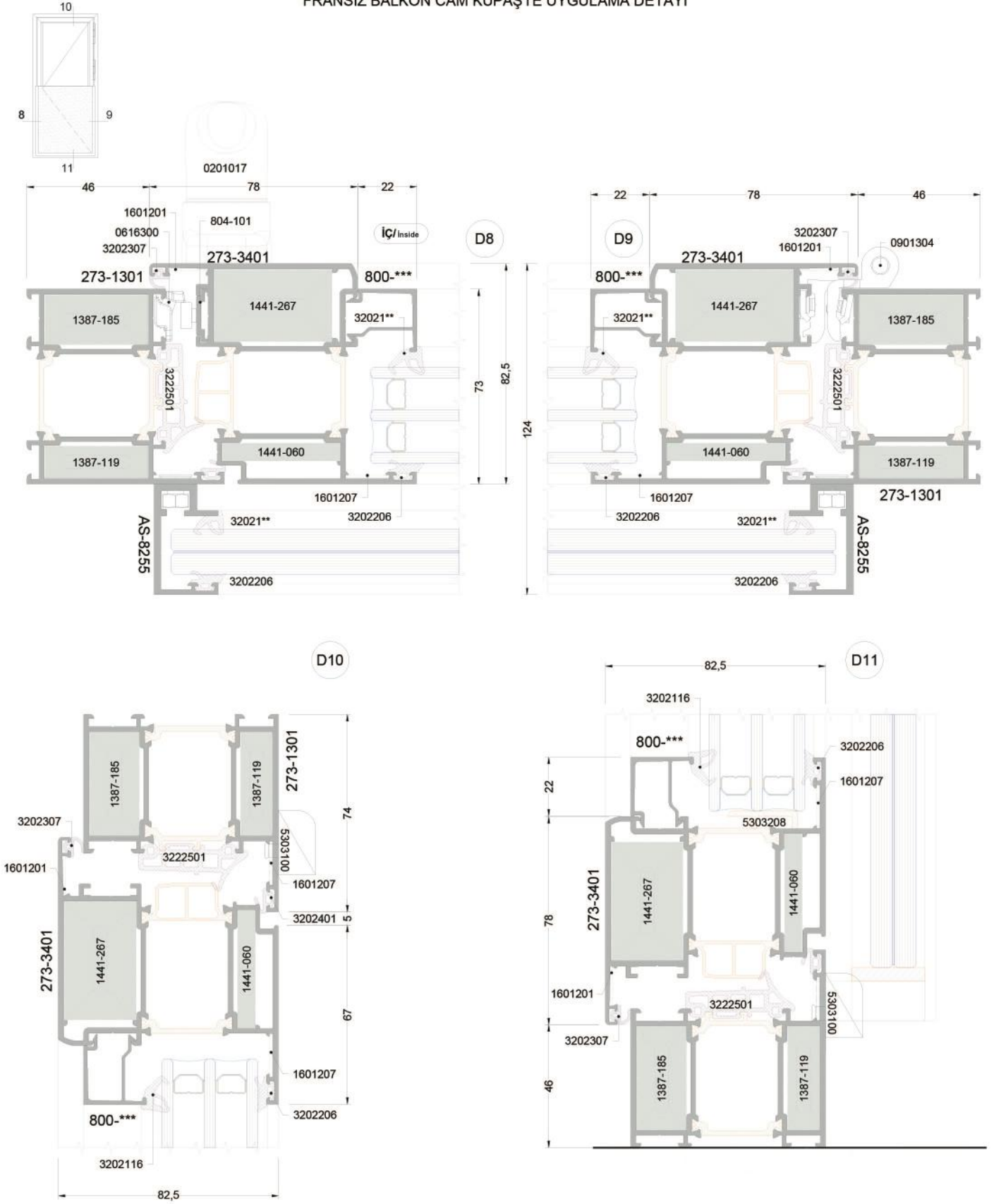

İÇ AÇILIM TEK KANAT KAPI DETAYI

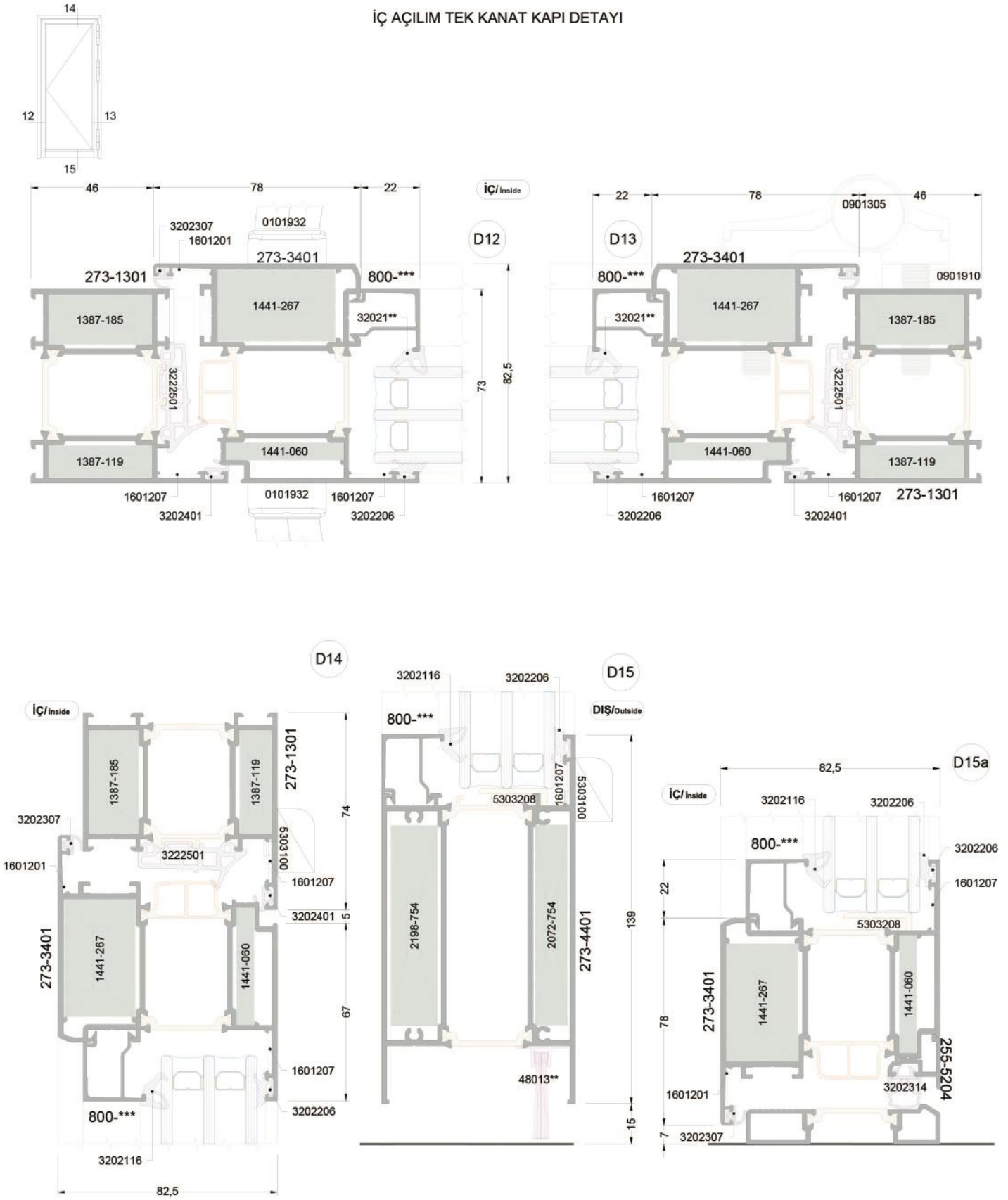

DIŞ AÇILIM TEK KANAT KAPI DETAYI

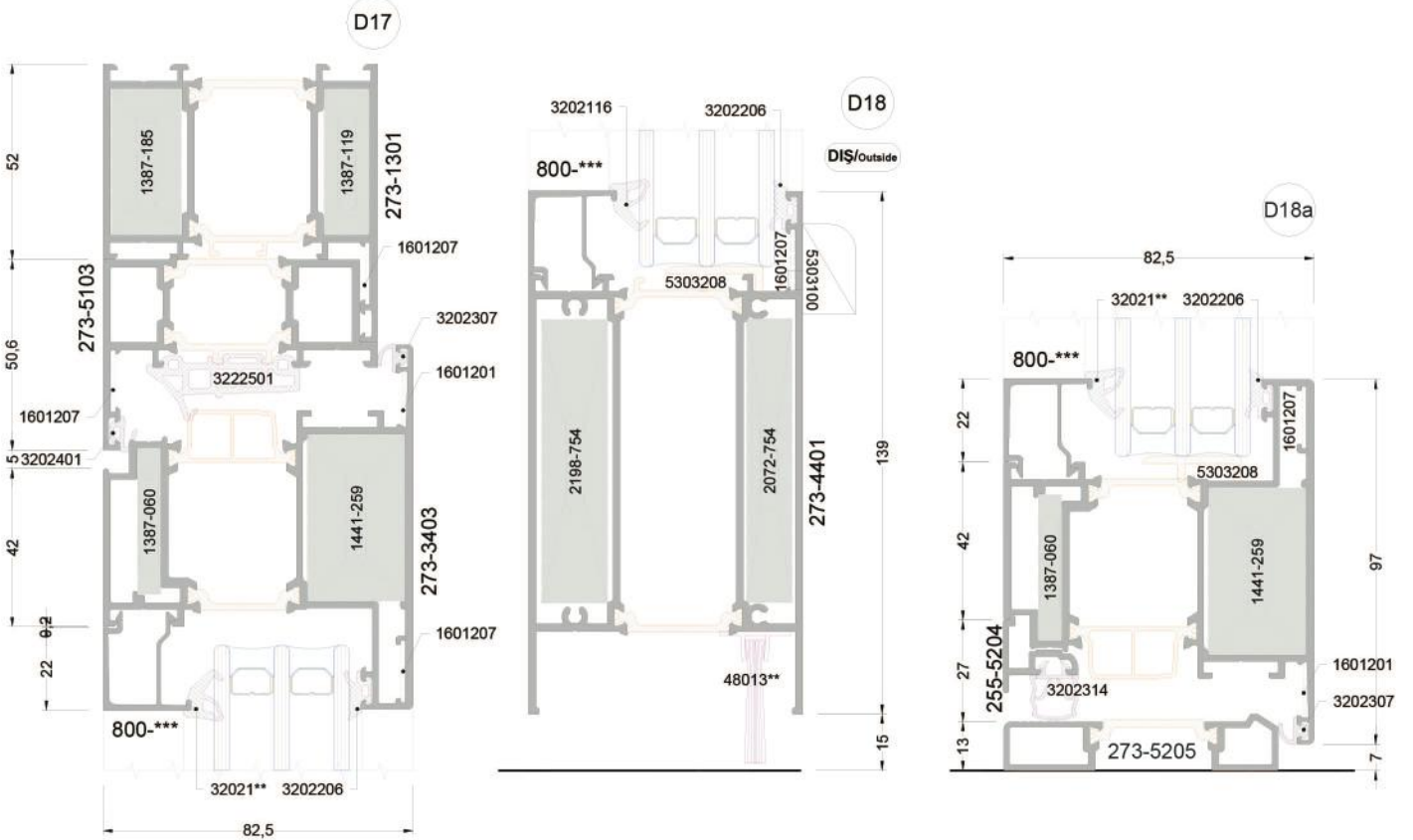
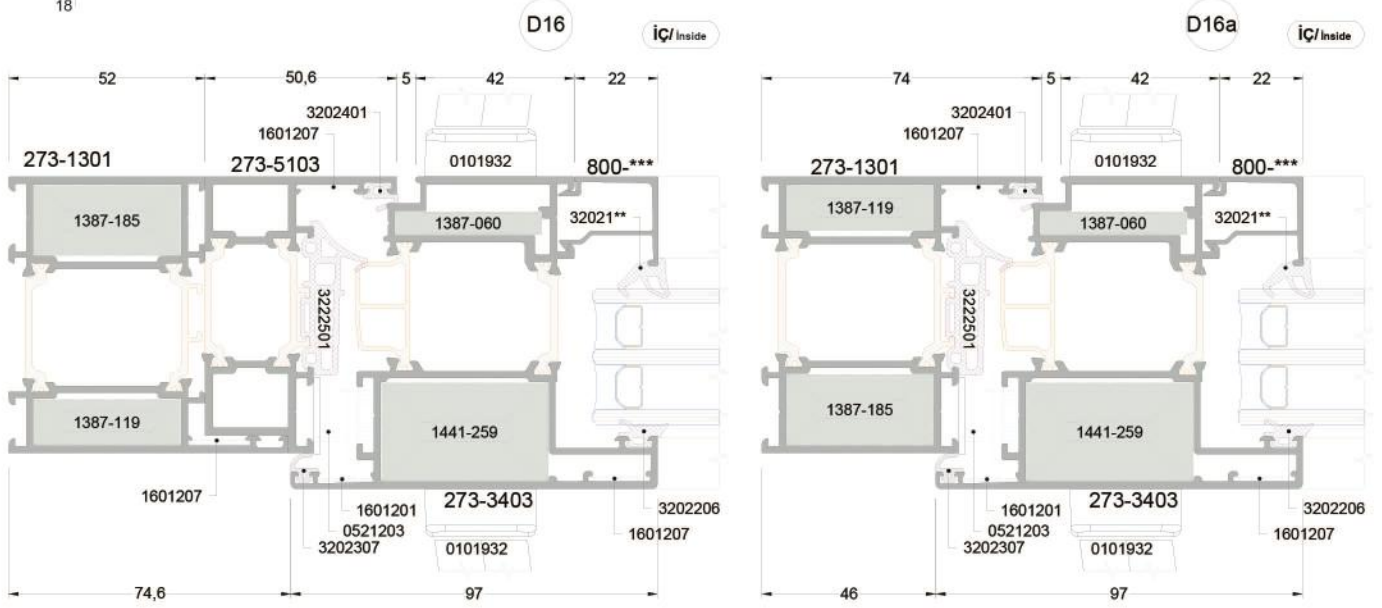
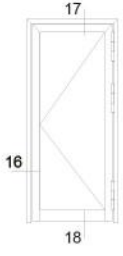

İÇ AÇILIM ÇİFT KANAT KAPI DETAYI

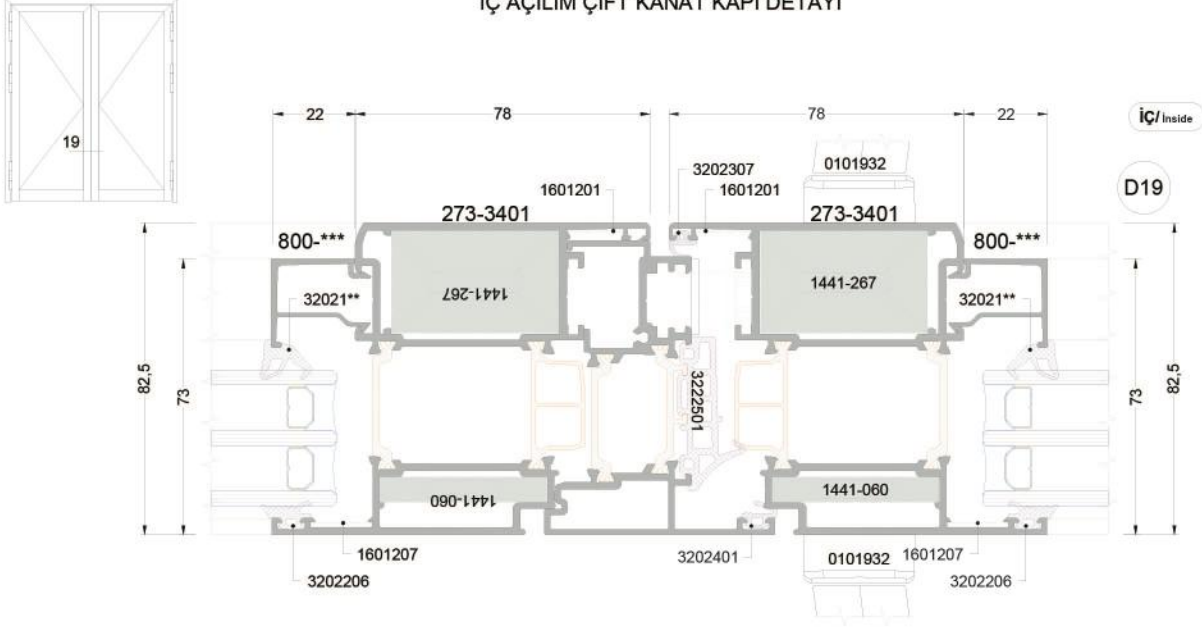

DIŞ AÇILIM ÇİFT KANAT KAPI DETAYI

