

SSA 140

CAM SÜRME SİSTEMİ

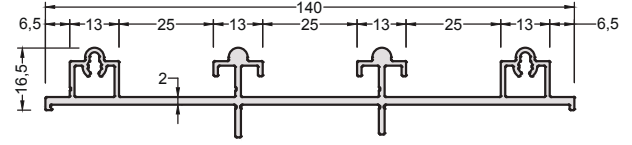
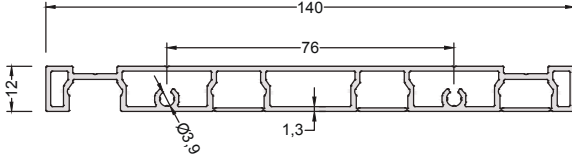

351-1101 (1,335 Kg/m)
SSA140 F01 KASA PROFİLİ

351-1102 (1,358 Kg/m)
SSA140 F02 RAY PROFİLİ

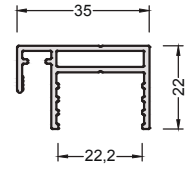
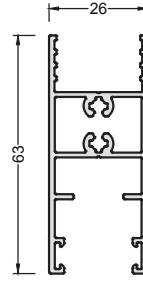
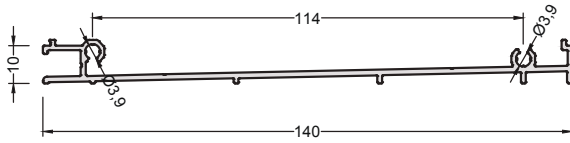

351-5001 (0,766 Kg/m)
SSA140 A01 DRENAJ PROFİLİ

351-2101 (0,867 Kg/m)
SSA140 V01 KANAT PR.

351-5102 (0,429 Kg/m)
SSA140 A02 KENET PR.

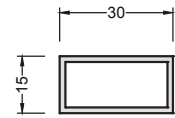
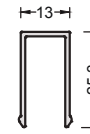
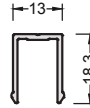
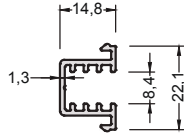
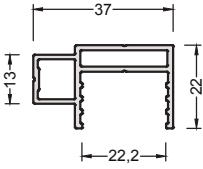

351-5103 (0,459 Kg/m)
SSA140 A03 90° KİLİT PR.

410-5001 (0,238 kg/mt)
TEK CAM ADAPTÖR PR.

351-5104 (0,158 Kg/m)
SSA140 A04 ADAPTÖR PR.

351-5105 (0,199 Kg/m)
SSA140 A05 ADAPTÖR PR.

SD-2563 (0,370 Kg/m)
KUTU 30*15 1,5 MM

ÜRÜN ÇİZİMİ	ÜRÜN KODU	ÜRÜN ADI	ÜRÜN ÇİZİMİ	ÜRÜN KODU	ÜRÜN ADI	ÜRÜN ÇİZİMİ	ÜRÜN KODU	ÜRÜN ADI
	3518201	ALT RULMAN		0101933	PENCERE KOLU İTHAL		3501901	KOL HAVUZ SÜRME DİL KARŞILIK
	3203701	KENET FİTİLİ		0101934	PENCERE KOLU İTHAL-SAĞ		3503606	PVC KENET KAPAK ALT
	3203009	FİRÇA FİTİL 6,5*550 mm		0101935	PENCERE KOLU İTHAL-SOL		3503607	PVC KENET KAPAK ÜST
	3516060	SÜRME İSPANYOLET 600/22		3601102	PASİF KANAT ÇEKME KOL		3503913	HAVA KESİCİ ALT
	3516080	SÜRME İSPANYOLET 800/22		3501912	İSPANYOLET KİLİT KARŞILIĞI		3503914	HAVA KESİCİ ÜST
	3516100	SÜRME İSPANYOLET 1000/22		0301100	HAVUZ KİLİT			
	3516140	SÜRME İSPANYOLET 1400/22		0301103	HAVUZ KİLİT OTOMATİK			
	3516160	SÜRME İSPANYOLET 1600/22		0321004	GÖMME ÇEKME KOL			
	3516180	SÜRME İSPANYOLET 1800/22		3501900	KOL HAVUZ SÜRME DİL			

UYGULAMA MODELLERİ

EŞİKLİ ve EŞİKSİZ AÇILIM MODELLERİ

4 Kanat

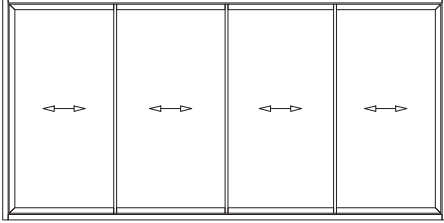

3 Kanat

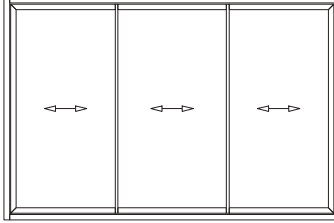

2 Kanat

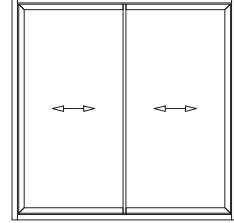

4 + 4 = 8 Kanat

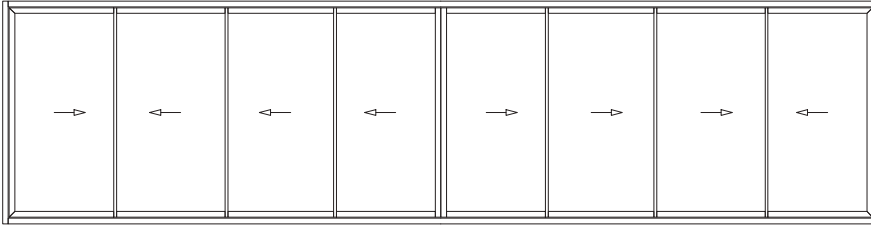

3 + 3 = 6 Kanat

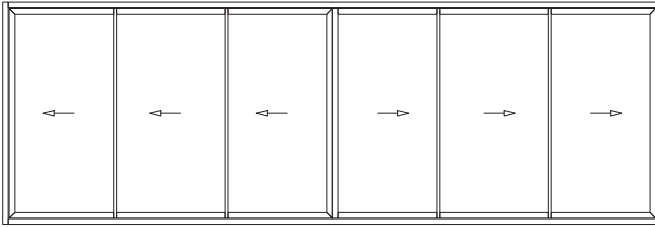

2 + 2 = 4 Kanat

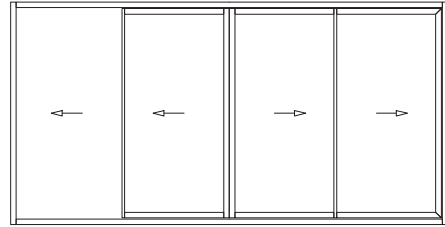

EŞİKLİ ve EŞİKSİZ 90° KÖŞE BİRLEŞİM MODELLERİ

4 / 4 Kanat

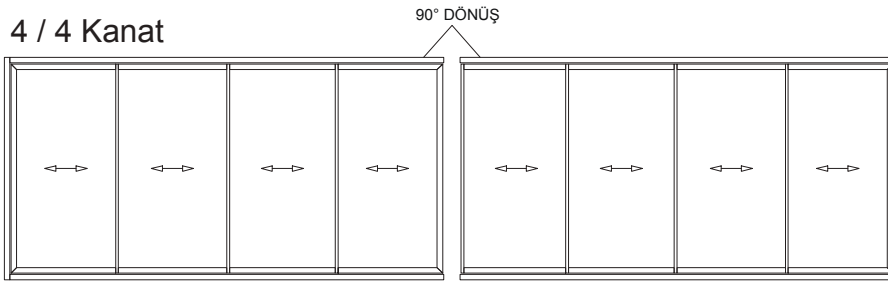

3 / 3 Kanat

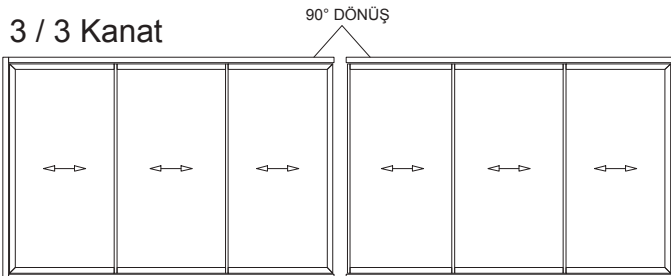

2 / 2 Kanat

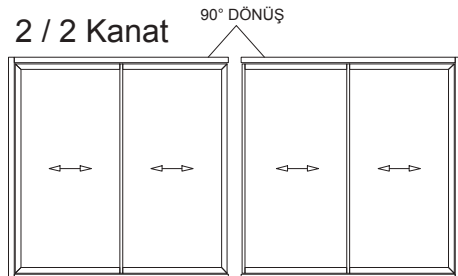

SSA 140

CAM SÜRME SİSTEMİ



ACCURACY

HARMONY

BALANCE

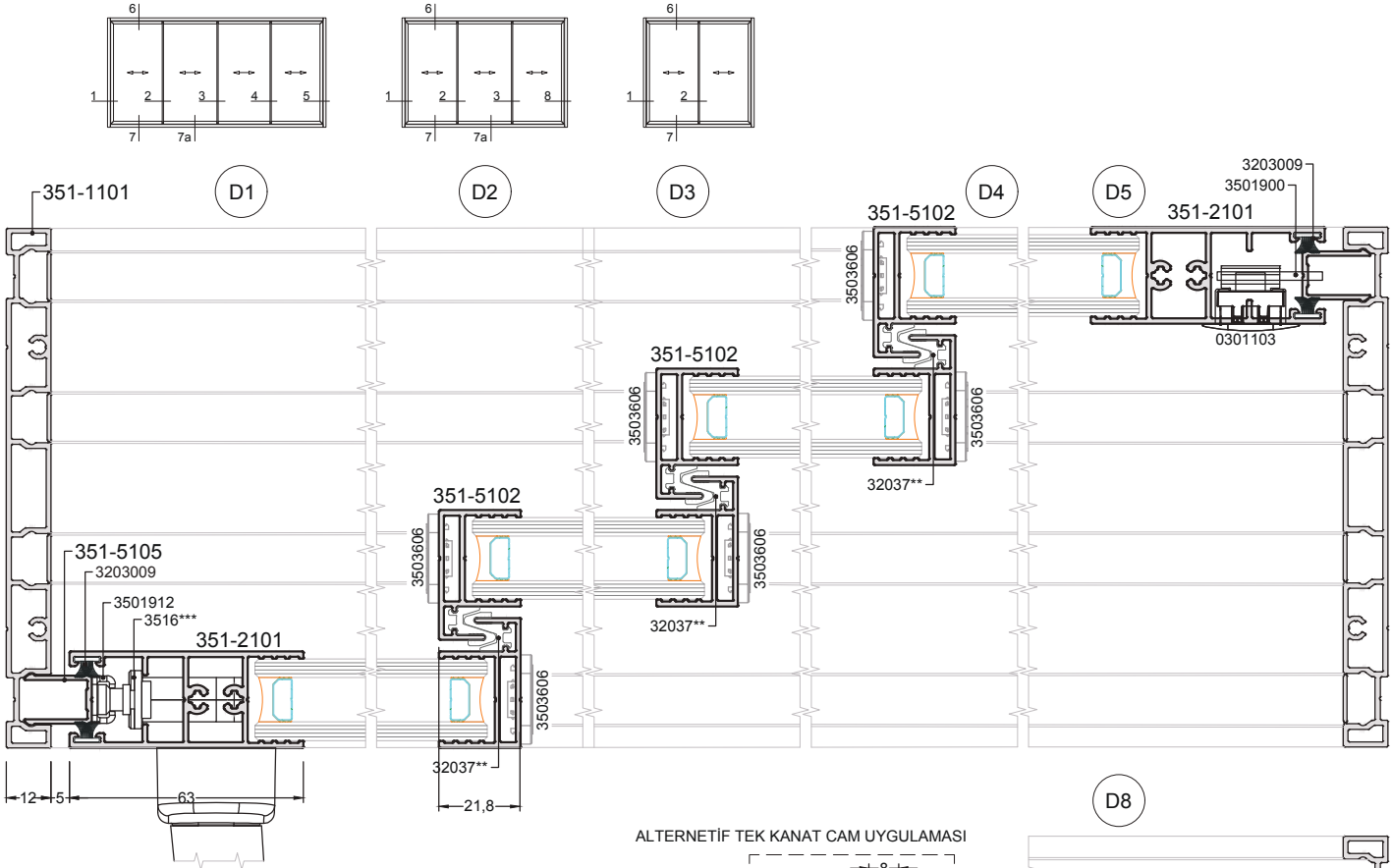

ALTERNETİF TEK KANAT CAM UYGULAMASI

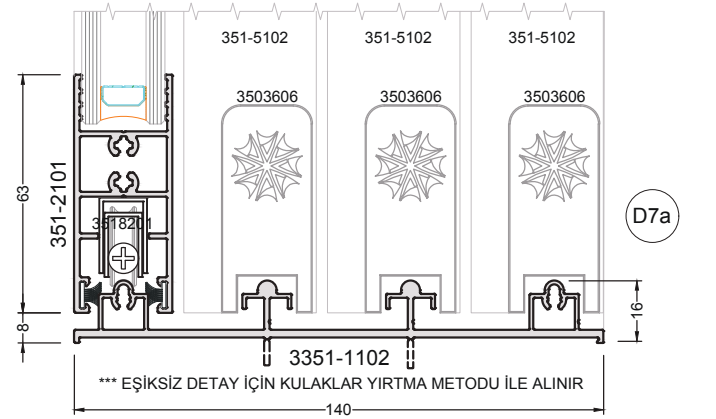
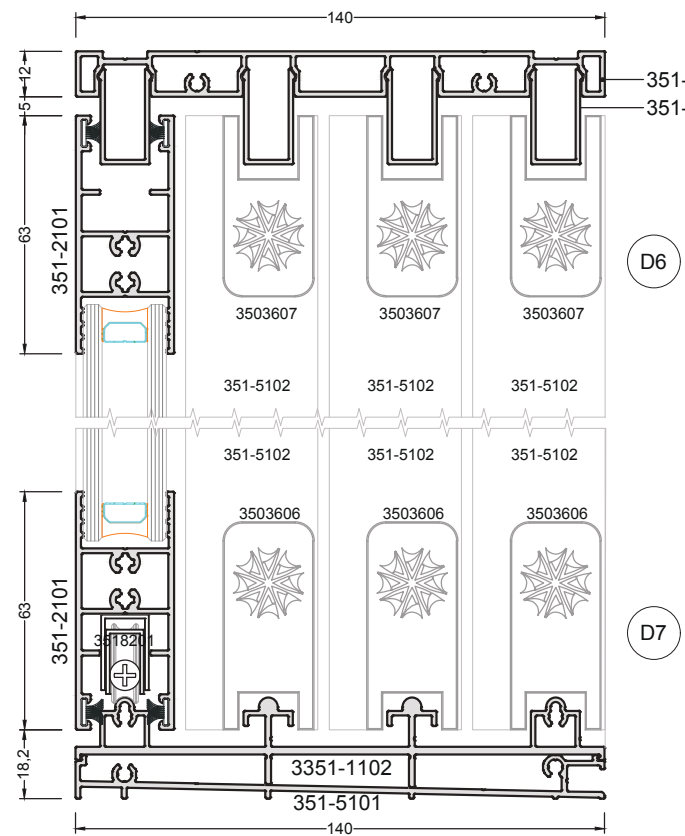
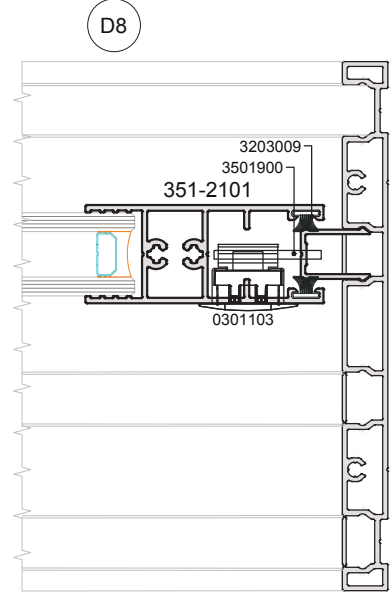
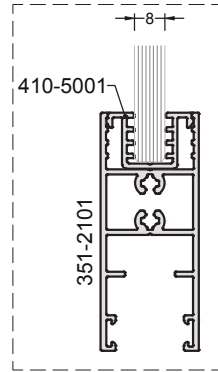

SSA 140

CAM SÜRME SİSTEMİ



ACCURACY

HARMONY

BALANCE

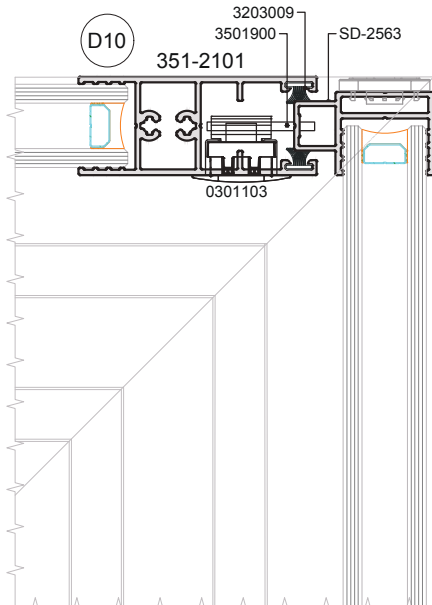
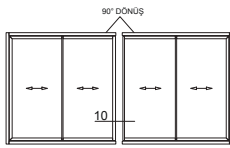
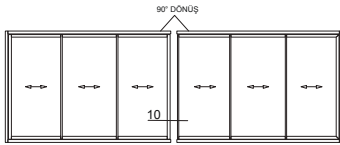
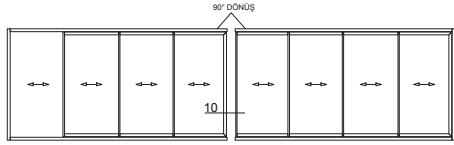
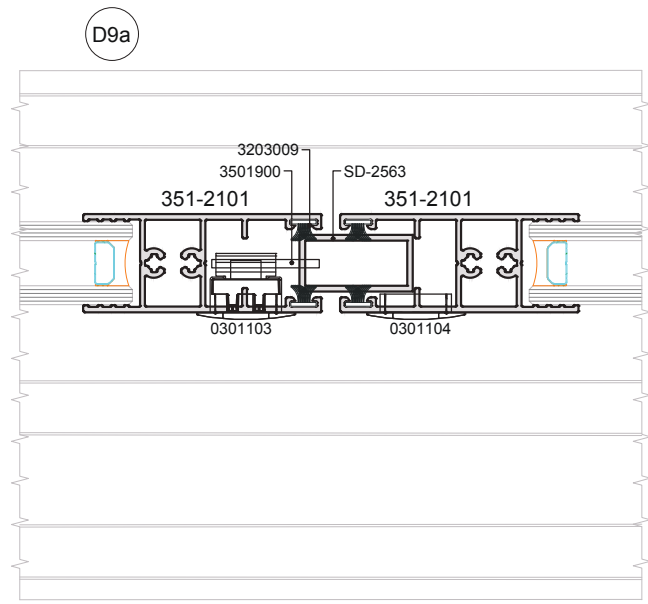
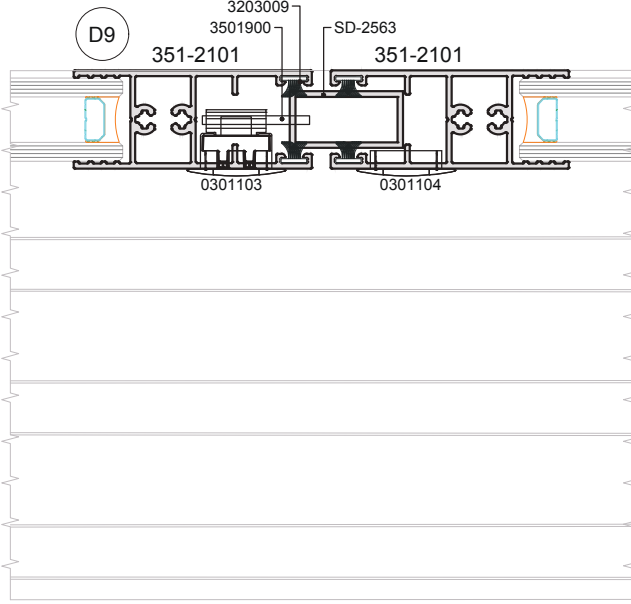
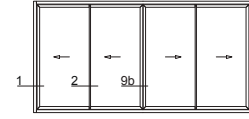
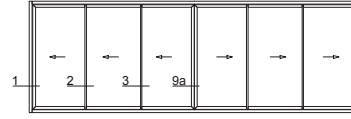
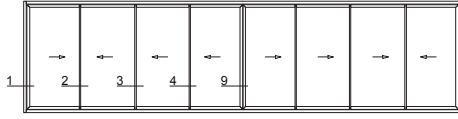

D9b

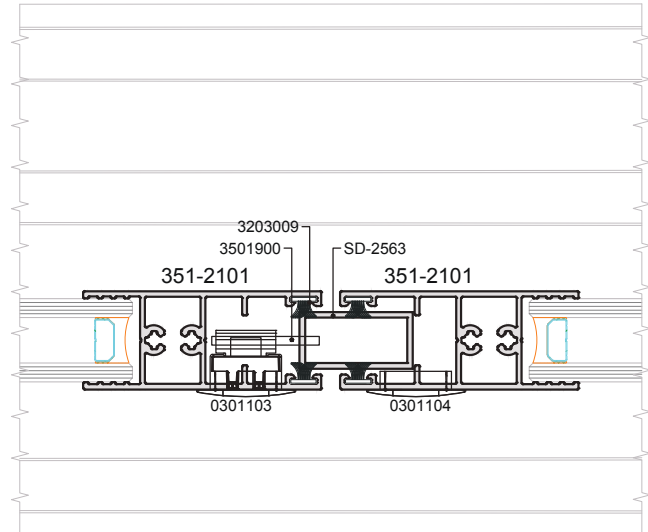

KÖŞE DÖNÜŞ UYGULAMALARINDA KANADIN DIŞTA VEYA İÇTE OLMASI, TAMAMEN UYGULAYICI FİRMANIN SEÇİM TERCİHİDİR.

SSA 140

CAM SÜRME SİSTEMİ



ACCURACY



HARMONY



BALANCE

ÜST KASA İMALATINDA ADAPTÖR PROFİLLERİNİN MONTAJI İÇİN KANAL KAPAMALARI PENSE v.b. EL ALETİ İLE YIRTMA METODU İLE KOLAYLIKLAKA AÇILIR. YAN KASA UYGULAMALARI İÇİN HERHANGİ BİR İŞLEM YAPILMAZ

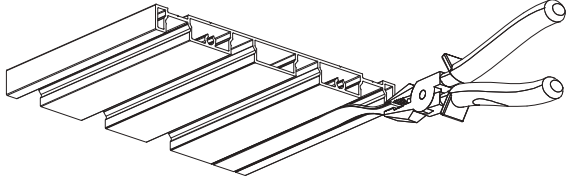

KANAL KAPAMALARI AÇILMASI İŞLEMİ SONRASI 351-5105 ADAPTÖR PROFİLİ ÇAKMA YÖNTEMİ İLE KANAL YUVALARINA YERLEŞTİRİLİR

351-5101 DRENAJ PROFİLİ İÇİN Ø5 mm FREZE/MATKAP UCU İLE TAHLİYE AÇILIR. AYNI İŞLEM 3351-1102 RAY PROFİLİNDE UYGULANIR

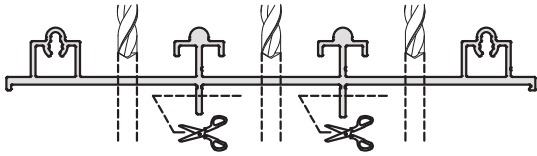
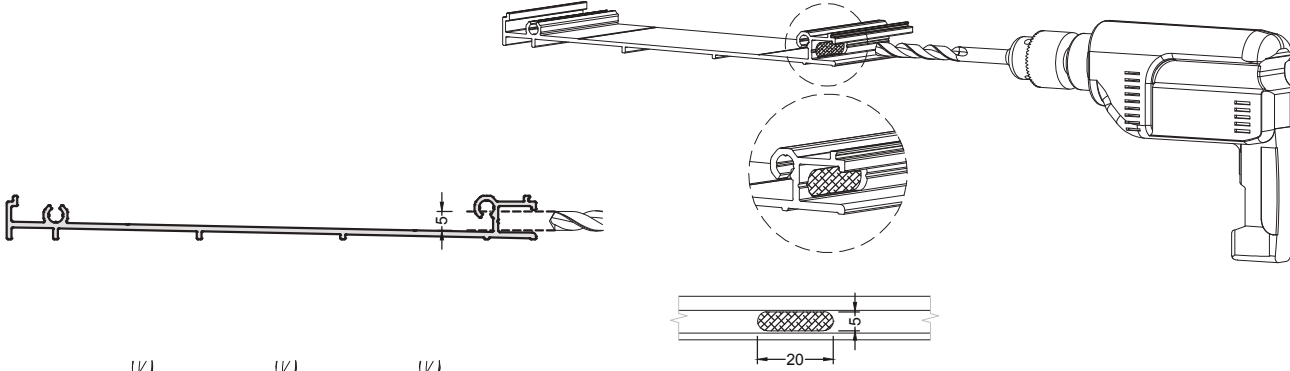

TAHLİYE İÇİN ALT KULAKLARDA DA BELLİRLİ ARALIKLARDA YIRTMA YAPILIR

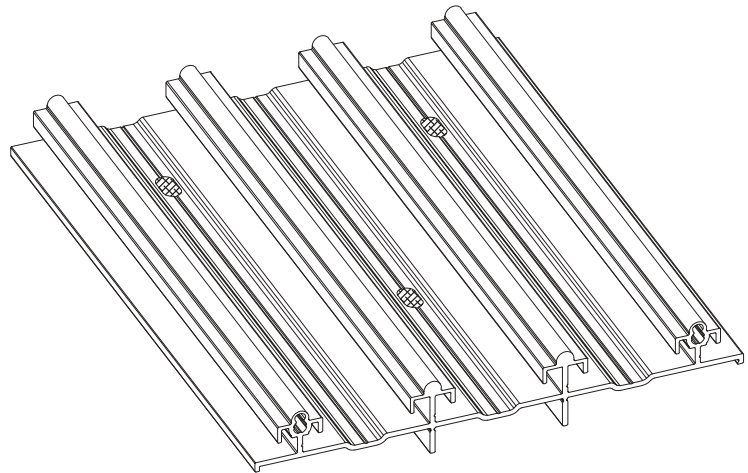
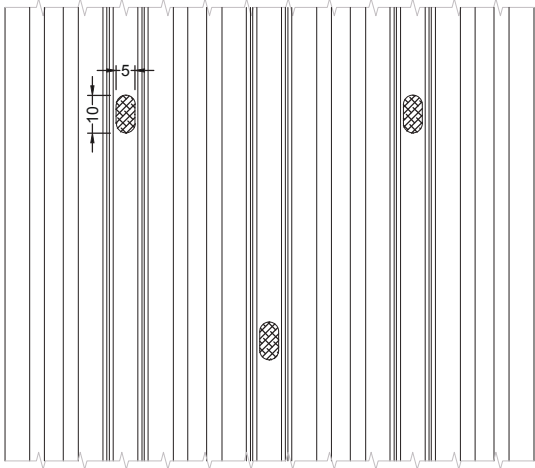



KENET PROFİLİ İÇİN KERTME ÖLÇÜLERİ

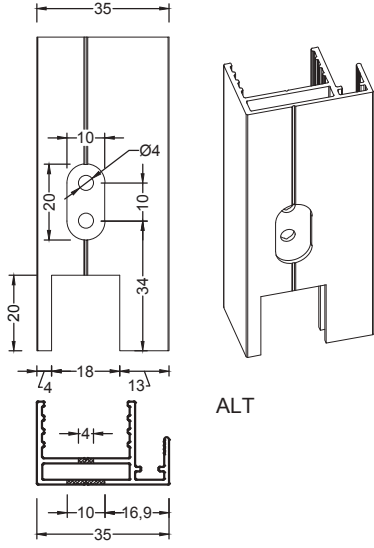

ALT

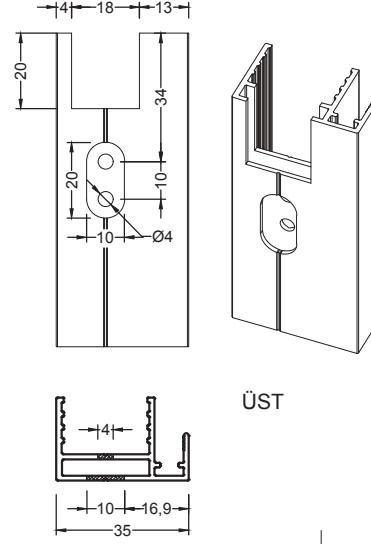

ÜST

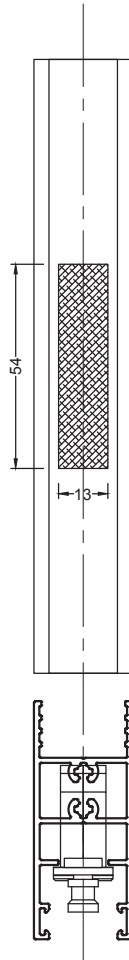
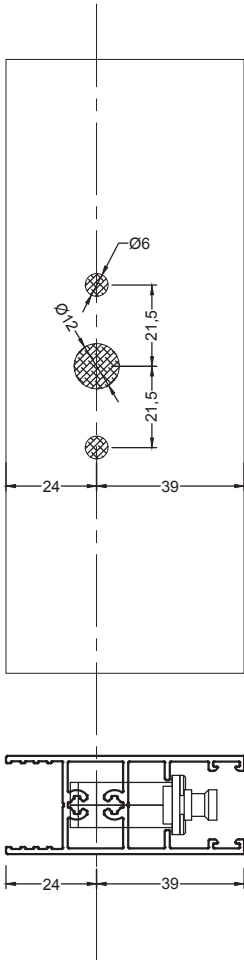

KANAT PROFİLİ İÇİN PVC İSPANYOLET
VE HAVUZ KOL DELİK ÖLÇÜLERİ

